



User manual

Energy storage integrated inverter

Product Model: HYD 5K~20KTL-3PH



Content

1. Basic safety information.....	- 1 -
1.1. Safety instructions.....	- 1 -
1.2. Symbols and signs.....	- 4 -
2. Product characteristics.....	- 6 -
2.1. Product informations.....	- 6 -
2.2. Size description.....	- 7 -
2.3. Function characteristics.....	- 7 -
2.4. Electrical block diagram.....	- 7 -
3. Application modes.....	- 9 -
3.1. Typical Energy Storage System.....	- 9 -
3.2. System Without PV Connection.....	- 10 -
3.3. System Without Battery.....	- 11 -
3.4. Back-up Mode (Without Grid).....	- 12 -
3.5. System With Multi Inverters.....	- 13 -
3.6. AC Retrofit System.....	- 15 -
3.7. Back-up Unbalanced Output.....	- 17 -
3.8. On-Grid Unbalanced Output.....	- 18 -
4. Installation.....	- 19 -
4.1. Installation Process.....	- 19 -
4.2. Checking Before Installation.....	- 19 -
4.3. Product Overview.....	- 22 -
4.4. Tools.....	- 22 -
4.5. Installation Environment.....	- 24 -
4.6. Determining the Installation Position.....	- 24 -
4.7. Moving the HYD 5-20KTL-3PH.....	- 25 -
4.8. Installing HYD 5-20KTL-3PH.....	- 26 -
5. Electrical Connections.....	- 27 -
5.1. Wire instructions.....	- 28 -
5.2. Connecting PGND Cables.....	- 29 -
5.3. Battery Connection & PV Connection.....	- 30 -
5.4. Load connection.....	- 31 -
5.5. Grid connection.....	- 32 -
5.6. External communication interface.....	- 33 -
5.7. Communication method.....	- 44 -
6. Buttons and indicator lights.....	- 48 -
6.1. Buttons.....	- 48 -
6.2. Indicator lights and status.....	- 48 -
7. Operation (commission)	- 49 -
7.1. Double Check.....	- 49 -
7.2. First Time Setup (IMPORTANT!).....	- 49 -
7.3. Menu.....	- 51 -
8. Troubleshooting.....	- 68 -
9. Technical Data.....	- 76 -
10. Quality Assurance.....	- 83 -

Notice

This manual contains important safety instructions that must be followed during installation and maintenance of the equipment.

Save these instructions!

This manual must be considered as an integral part of the equipment. The manual must always accompany the equipment, even when it is transferred to another user or field.

Copyright Declaration

The copyright of this manual belongs to Shenzhen SOFARSOLAR Co., Ltd. Any corporation or individual should not plagiarize, partially copy or fully copy it (including software, ect .), and no reproduction or distribution of it in any form or by any means. All right reserved.

SOFARSOLAR reserves the right of final interpretation. This manual is subject to change according to user's or customer's feedback. Please check our website at <http://www.sofarsolar.com> for latest version.

The current Version updated at 20210401.

Preface

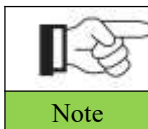

If you have any question or problem when you read the following information, please contact Shenzhen SOFARSOLAR Co., Ltd.

Outline

Please read the product manual carefully before installation, operation or maintenance. This manual contains important safety instructions and installation instructions that must be followed during installation and maintenance of the equipment.

Scope

This product manual describes the installation, electrical connections, commissioning, maintenance and troubleshooting of HYD 5-20KTL-3PH inverters:

HYD 5KTL-3PH	HYD 6KTL-3PH
HYD 8KTL-3PH	HYD 10KTL-3PH
HYD 15KTL-3PH	HYD 20KTL-3PH





Keep this manual where it will be accessible at all times.

Target Group

This manual is intended for qualified electrical technical personnel who are responsible for inverter installation and commissioning in the PV power system and PV plant operator.

Symbols Used

This manual provides safety operation information and uses the symbol in order to ensure personal and property security and property security and use inverter efficiently when operating the inverter. You must understand these emphasized information to avoid the personal injury and property loss. Please read the following symbols used in this manual carefully.

 Danger	<p>Danger indicates a hazardous situation which, if not avoided, will result in death or serious injury.</p>
 Warning	<p>Warning indicates a hazardous situation which, if not avoided, could result in death or serious injury.</p>
 Caution	<p>Caution indicates a hazardous situation which, if not avoided, could result in minor or moderate injury.</p>
 Attention	<p>Attention indicates potential risks which, if not avoided, may lead to equipment fault or property damage.</p>
 Note	<p>Note provides tips that are valuable for the optimal operation of the product.</p>

1. Basic safety information

1.1. Safety instructions

Read and understand the instructions of this manual, and be familiar with relevant safety symbols in this chapter, then start to install and troubleshoot the equipment.

According to the national and state requirements, before connecting to the electrical grid, you must get permission from the local electrical grid operation can only be performed by qualified electrical engineer.

Please contact the nearest authorized service center if any maintenance or repair is needed. Contact your distributor for the information of the nearest authorized service center. Do NOT repair it by yourself, it may cause injury or property damage.

Before installing and maintaining the equipment, you should turn the DC switch OFF to cut off the high voltage DC of the PV array. You can also turn the switch in the PV combiner box OFF to cut off the high voltage DC. When the battery needs to be installed, please confirm the positive and negative terminals of the battery and turn OFF the battery. Otherwise, serious injury may be caused.

Qualified persons

The customer must make sure the operator has the necessary skill and training to do his/her job. Staff in charge of using and maintaining the equipment must be skilled, aware and mature for the described tasks and must have the reliability to correctly interpret what is described in the manual. For safety reason only a qualified electrician, who has received training and / or has demonstrated skills and knowledge in construction and in operation of this unit, can install this inverter. Shenzhen SOFARSOLAR Co., Ltd. does not take any responsibility for the property destruction and personal injury because of any incorrect use.

Installation requirements

Please install inverter according to the following section. Fix the inverter on an appropriate objects with enough load bearing capacity (such as walls, PV racks etc.), and ensure that inverter is vertical placed. Choose a place suitable for

installing electrical devices. And assure there is enough fire exit space, convenient for maintenance. Maintain proper ventilation to ensure enough air cycle to cool the inverter.

Transport requirements

If you find packing problems that may cause the damage of the inverter, or find any visible damage, please immediately notice the responsible transportation company. You can ask solar equipment installation contractor or Shenzhen SOFARSOLAR Co.Ltd. for help if necessary.

Transport of the equipment, especially by road, must be carried out with by suitable ways and means for protecting the components (in particular, the electronic components) from violent shocks, humidity, vibration, etc.

Labels on the equipment

The labels must NOT be hidden with objects and extraneous parts (rags, boxes, equipment, etc.); they must be cleaned regularly and kept visible at all times.

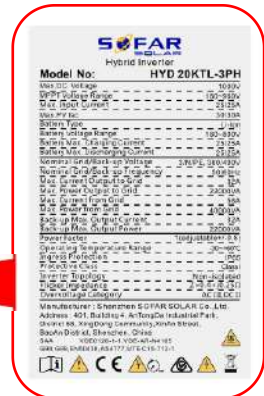
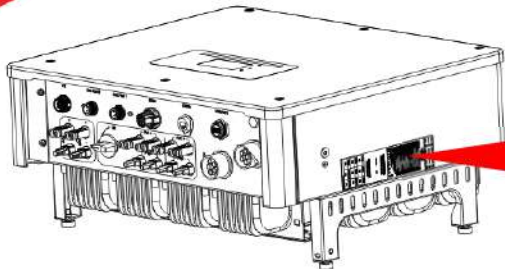



Electric connection



Please comply with all the current electrical regulations about accident prevention in dealing with the solar invert.





Before the electrical connection, make sure to use opaque material to cover the PV modules or to disconnect PV array DC switch. Exposure to the sun, PV array will produce a dangerous voltage!

	All installation accomplished only by professional electrical engineer! Must be trained; Completely read the manual operation and understand relevant matter.
Warning	
	Get permission from the local electrical grid operator, complete all electrical connections by professional electrical engineer, then connect inverter to electrical grid.
Attention	
	It's forbidden to remove the tamper evident label, or open the inverter. Otherwise Sofarsolar will not provide warranty or maintenance!
Note	

Operation

	Touching the electrical grid or the terminal of the equipment may lead to electrocution or fire! Don't touch the terminal or conductor connected to the electrical grid. Pay attention to any instructions or safety documents related to grid connection.
Danger	
	Some internal components will be very hot when inverter is working. Please wear protective gloves! Keep it away from kids !
Attention	

Maintenance and repair

	Before any repair work, turn OFF the AC circuit breaker between the inverter and electrical grid first, then turn OFF the DC switch. After turning OFF the AC circuit breaker and DC switch, wait for 5 minutes at least before carrying out any maintenance or repair work.
Danger	
	Inverter should work again after removing any faults. If you need any repair work, please contact with the local authorized service center. Can't open the internal components of inverter without authorized. Shenzhen SOFARSOLAR Co., Ltd. does not take any responsibility for the losses from that.
Attention	



EMC / noise level of inverter

Electromagnetic compatibility (EMC) refers to that one electrical equipment functions in a given electromagnetic environment without any trouble or error, and impose no unacceptable effect upon the environment. Therefore, EMC represents the quality characters of an electrical equipment. The inherent noise-immune character: immunity to internal electrical noise. External noise immunity: immunity

to electromagnetic noise of external system.Noise emission level: influence of electromagnetic emission upon environment.







	<p>Electromagnetic radiation from inverter may be harmful to health! Please do not continue to stay around the inverter in less than 20 cm when inverter is working.</p>
<p>Danger</p>	





1.2. Symbols and signs

	<p>Caution of burn injuries due to hot enclosure! You can only touch the screen and pressing key of the inverter while it's working.</p>
<p>Caution</p>	
	<p>PV array should be grounded in accordance to the requirements of the local electrical grid operator! We suggest that all PV module frames and inverter are reliably grounded to protect the PV system and personnel security.</p>
<p>Attention</p>	
	<p>Ensure input DC voltage < Max. DC voltage .Over voltage may cause permanent damage to inverter or other losses, which will not be included in warranty!</p>
<p>Warning</p>	

Signs on the inverter

There are some symbols which are related to security on the inverter. Please read and understand the content of the symbols, and then start the installation.

	<p>This symbol indicates a hazardous situation which could result in injuries, if not avoided.</p>
	<p>There is a residual voltage in the inverter! Before opening the equipment, operator should wait for five minutes to ensure the capacitor is discharged completely.</p>
	<p>Caution, risk of electric shock.</p>
	<p>Caution hot surface.</p>
	<p>Comply with the Conformance Européenne (CE) certification.</p>
	<p>Grounding point.</p>
	<p>Please read this manual before install HYD 5-20KTL-3PH.</p>

	<p>This indicates the degree of protection of the equipment according to IEC standard 70-1 (EN 60529 June 1997).</p>
	<p>Positive pole and negative pole of the input voltage (DC).</p>
	<p>This side up, HYD 5-20KTL-3PH inverter must always be transported, handled and stored in such a way that the arrows always point upwards.</p>
	<p>RCM (Regulatory Compliance Mark) The product complies with the requirements of the applicable Australian standards.</p>

2. Product characteristics

2.1. Product informations

HYD 5-20KTL-3PH inverter is a three-phase photovoltaic energy storage inverter integrating grid-connected photovoltaic inverter and battery energy storage.

The HYD 5-20KTL-3PH inverter has a variety of built-in operating modes to suit the diverse user needs.

The HYD 5-20KTL-3PH inverter can provide a complete solution in the period of rising energy costs such as oil and coal, the energy subsidy of photovoltaic grid-connected system keeps falling. In the period of continuous power supply and emergency power supply demand in mountainous areas or base stations without power grid.

Fig. 2-1 HYD 5-20KTL-3PH inverter system diagram

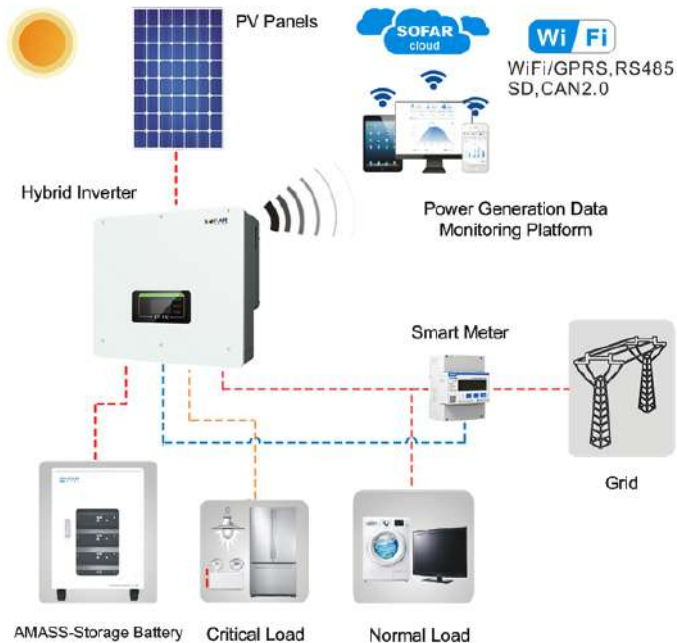

2.2. Size description

Fig. 2-2 Size chart

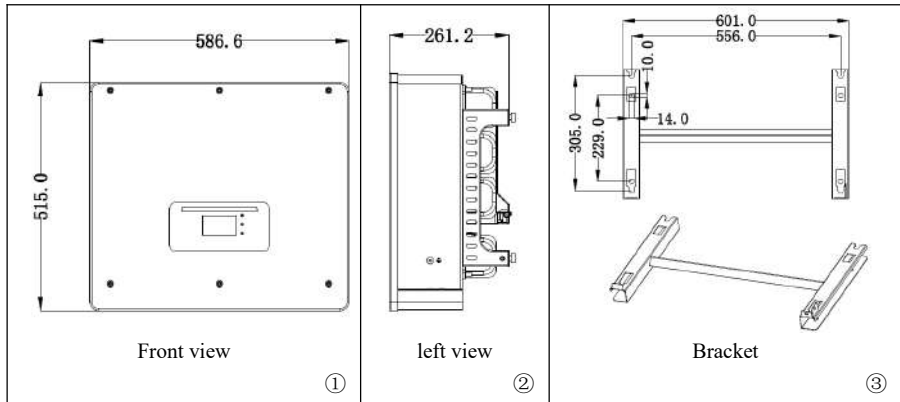

2.3. Function characteristics

The HYD 5-20KTL-3PH energy storage inverters allow up to 10% overloading to maximize power output, and the Uninterruptible Power Supply (UPS) mode can support inductive loads such as air conditioners or refrigerators with an automatic switchover time of less than 20 milliseconds.

- a. Dual MPP trackers with 1.5* DC overload.
- b. Flexible switching between grid-tied mode and energy storage mode.
- c. Max. battery charge and discharge efficiency 97.8%.
- d. 2 strings of battery input with maximum 50A charge and discharge current.
- e. Wide battery voltage range(180-800V).
- f. Off-grid output can be connected to unbalanced load.
- g. AC Multi-parallel function, more flexible system solution.
- h. Smart monitoring, RS485/WiFi/Bluetooth/GPRS(Optional).

2.4. Electrical block diagram

Fig. 2-3 Electrical block diagram

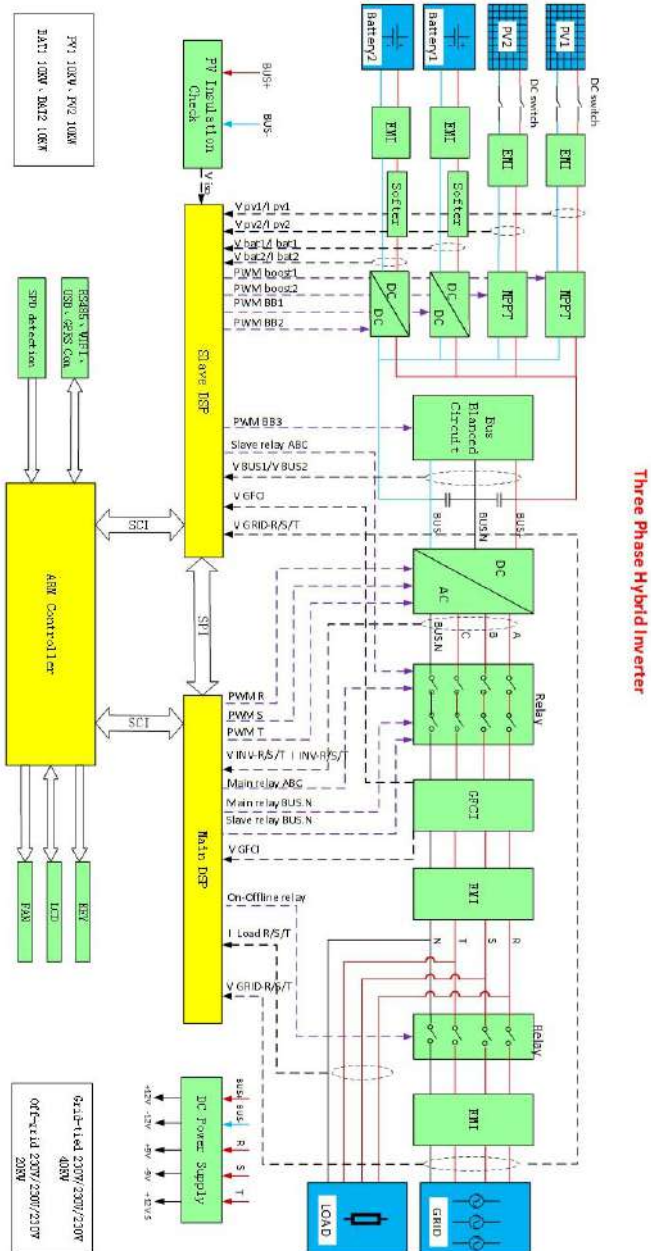

3. Application modes

3.1. Typical Energy Storage System

A typical energy storage system ,when you first design the system, you have already included PV, battery and calculated the load capacity that needs to be sustained by the hybrid inverter. This is the whole system design.

Fig. 3-1 Typical Energy Storage System

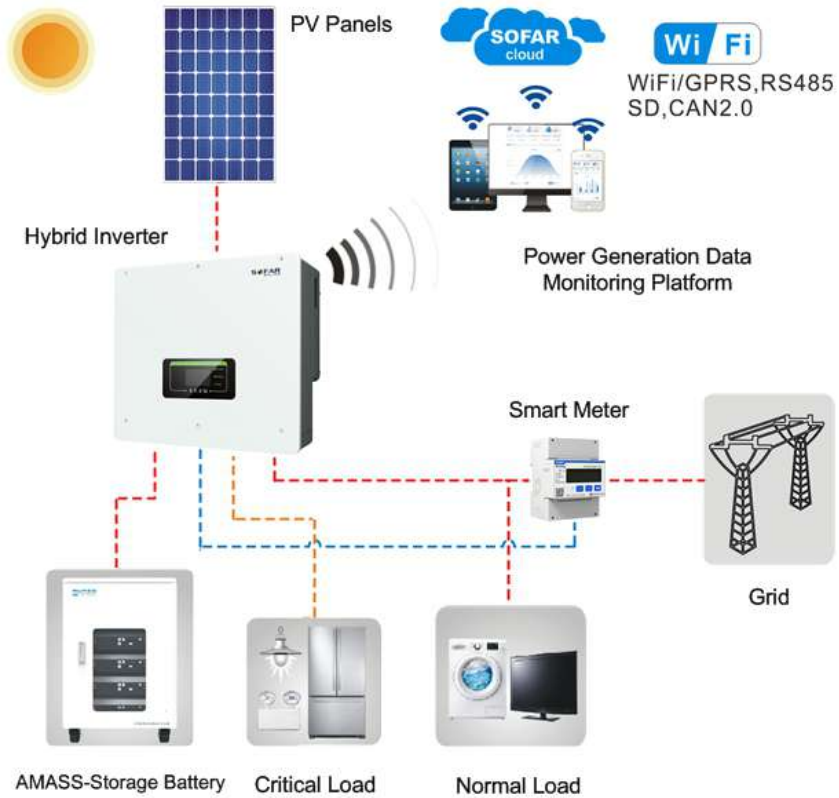

3.2. System Without PV Connection

- 1) There is no space to install the PV panel.
- 2) You don't want to install PV.
- 3) You want to install the PV later time.

This is the system configuration, and battery will be charged by the grid.

Fig. 3-2 System Without PV Connection



3.3. System Without Battery

- 1) You want just a grid-tied system.
- 2) You may add battery in the future.

This is the system configuration, battery function is always there, once you need, add it.

Fig. 3-3 System Without Battery



3.4. Back-up Mode (Without Grid)

- 1) The grid is down.
- 2) You don't want to use grid in peak hour.

This is the system configuration. If the PV is available, power will come from PV, or battery will sustain the critical load.

Fig. 3-4 Back-up Mode (Without Grid)

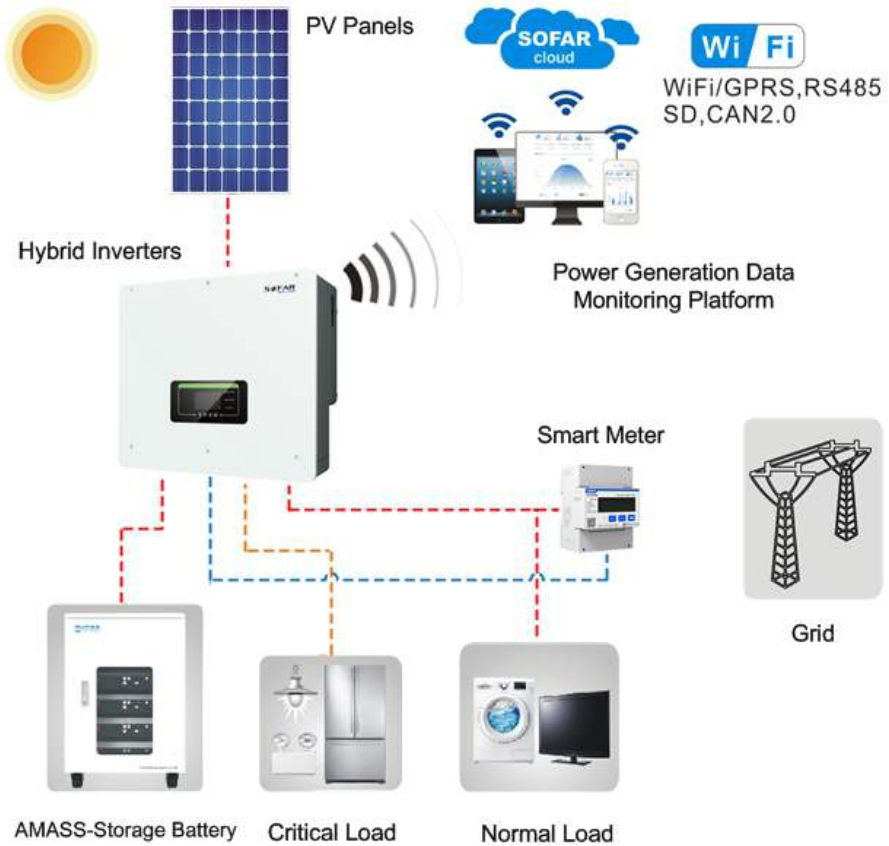

3.5. System With Multi Inverters

- 1) The system capacity is higher than 20kW.
- 2) PV panel is needed and enough space to install it.
- 3) Battery is needed for emergency or peak hour.

A parallel connection system for both AC output and Load output is the choice, maximum supports 10 units. So the system capacity will range from 5-200kW, which makes it possible for a lot application scenarios.

Fig. 3-5 System With Multi Inverters

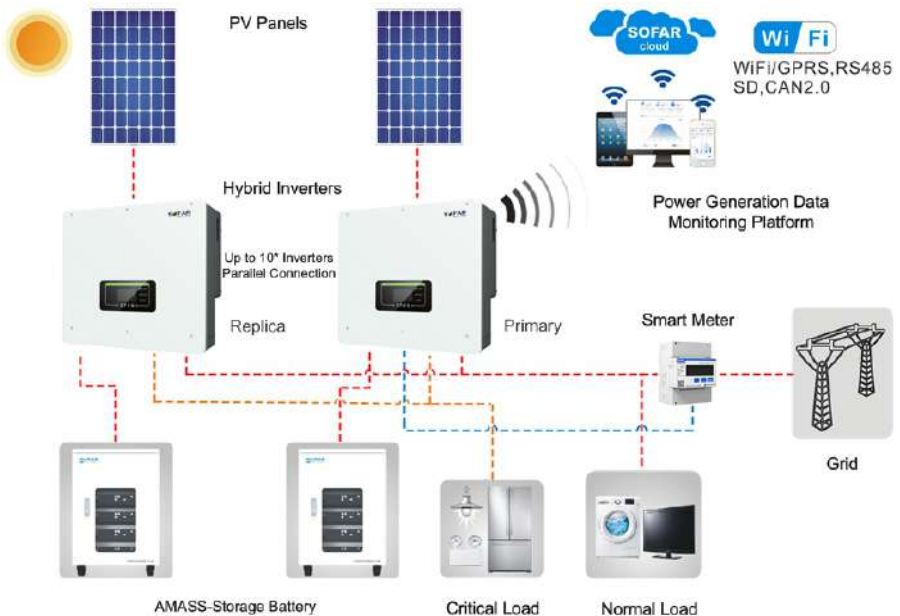

Note(AC LOAD is also parallel for parallel machines):

1. It is recommended that the AC LOAD output wiring of all machines should be combined together and connected to the LOAD by THE AC circuit breaker. It is not recommended that each machine should be connected to the AC circuit breaker separately to avoid the possibility that the power allocated to other machines will exceed the maximum allowable LOAD power of a single AC circuit breaker due to its disconnection.
2. It is recommended that AC GRID output wiring of all machines should be combined together and connected to the power GRID through AC circuit breaker. It is not recommended that each machine should be connected to AC circuit breaker

separately to the power GRID, because when the AC circuit breaker connected to a single machine is disconnected, the AC GRID end of this machine still has AC power, so as to avoid electric shock caused by operator's wrong judgment.

3. The cable length of the AC LOAD terminal connected from the LOAD terminal to each machine shall be consistent with the specification of the cable length, so as to ensure that the loop impedance is consistent and the current of the LOAD current diverted to each machine is nearly equal.

4. When the total power of AC Load is greater than 110% of the rated power of the machine (For example, one 20KW machine AC LOAD has a maximum allowable power of 22kVA and five parallel machines AC LOAD has a maximum allowable power of 110kVA) , the Load should not be connected to AC Load and should be connected to AC Grid.

3.6. AC Retrofit System

- 1) Grid-tied solar system has already existed.
- 2) More capacity of power is needed.
- 3) Battery is needed for emergency.
- 4) Extra space for PV panel.

This is the solution can satisfy all the needs.

Fig. 3-6 AC Retrofit System(1)

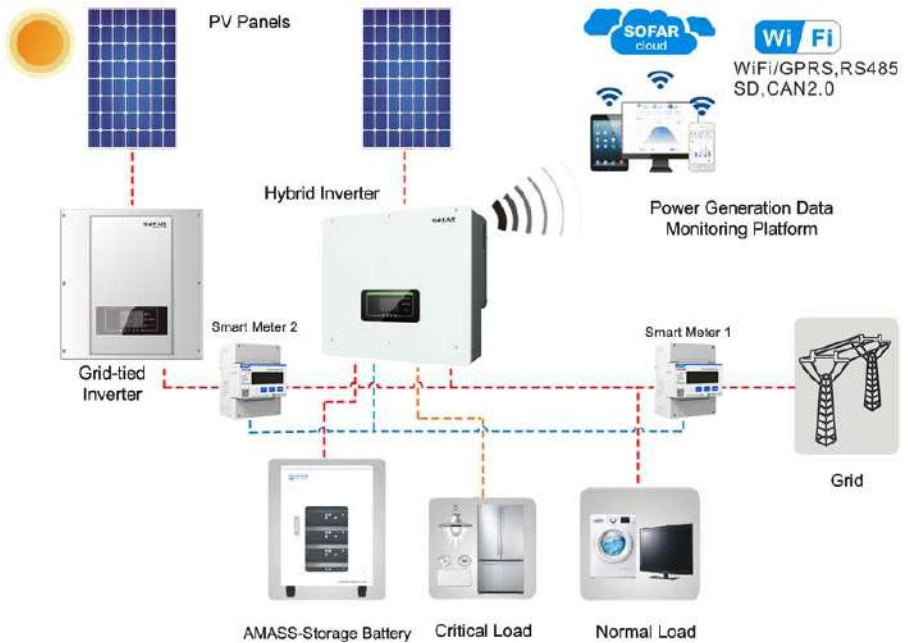

- 1) Grid-tied solar system has already existed.
- 2) More capacity of power is needed.
- 3) Battery is needed for emergency.
- 4) No extra space for PV panel.

This is the solution can satisfy all the needs.

Fig. 3-7 AC Retrofit System(2)

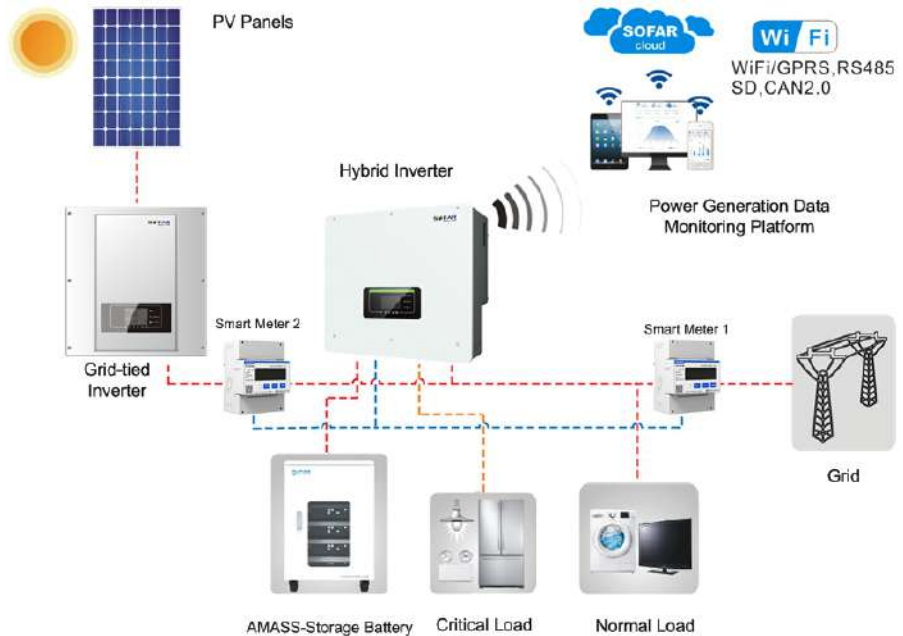

3.7. Back-up Unbalanced Output

- 1) The critical load is single phase.
- 2) The critical load of three phase are the same or unbalanced.

This is the best solution to satisfy your needs.

Fig. 3-8 Back-up Unbalanced Output

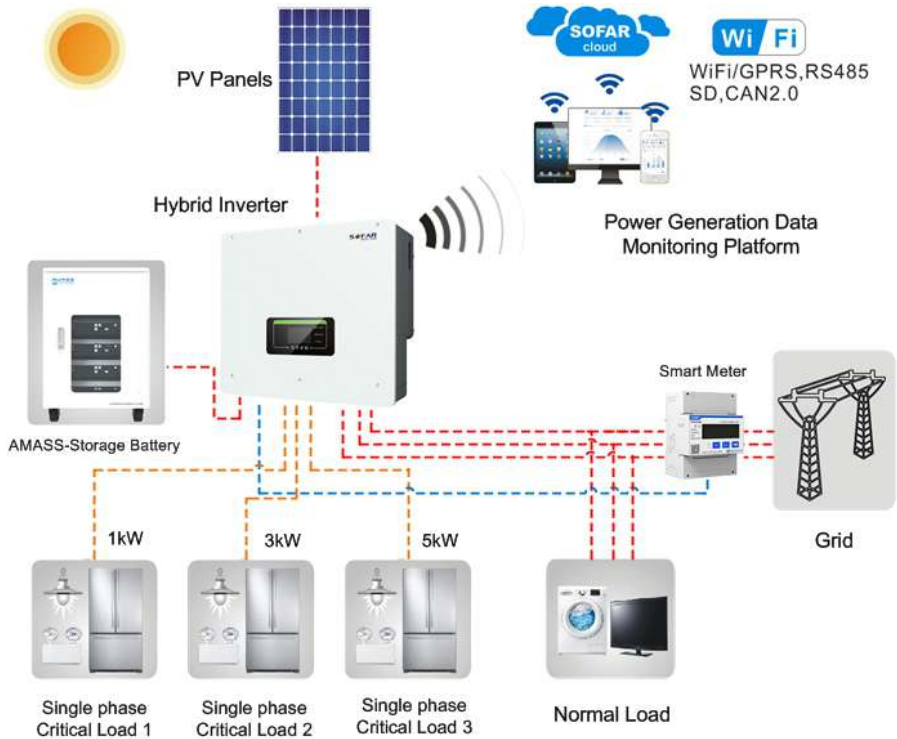

3.8. On-Grid Unbalanced Output

- 1) The normal load is single phase.
- 2) The normal load of three phase are the same or unbalanced.

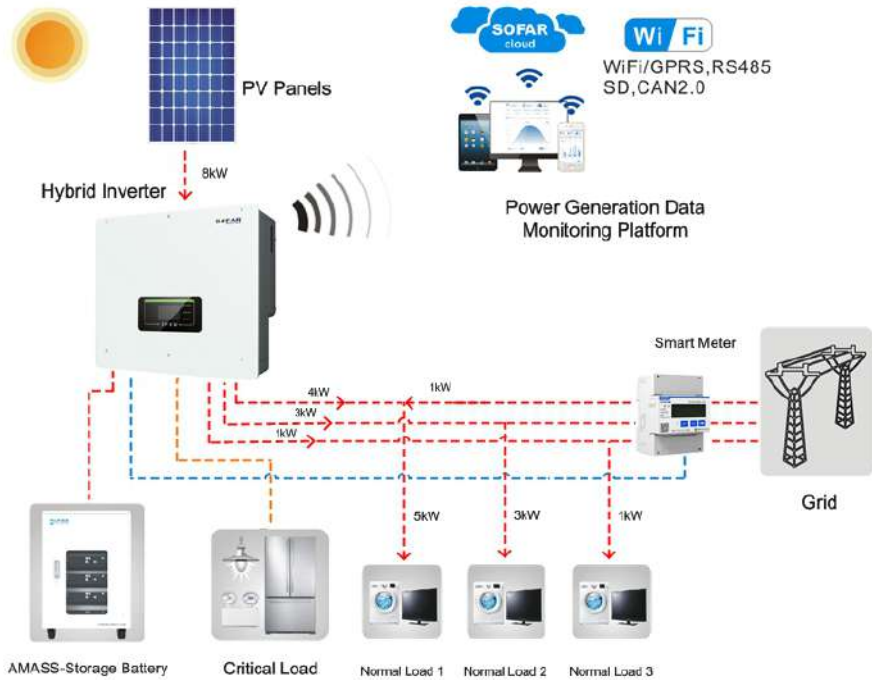

This is the best solution to satisfy your needs.

Fig. 3-9 On-Grid Unbalanced Output



4. Installation

Installation notes

 Dager	<p>Do NOT install the HYD 5-20KTL-3PH on flammable material. Do NOT install the HYD 5-20KTL-3PH in an area used to store Flammable or explosive material.</p>
 Caution	<p>The enclosure and heat sink are very hot while the inverter is working, therefore do NOT install the HYD 5-20KTL-3PH in places where you might touch them inadvertently.</p>
 Attention	<p>Consider the weight of HYD 5-20KTL-3PH when transporting and moving the inverters. Choose an appropriate mounting position and surface. Assign at least two persons to install the inverter.</p>

4.1. Installation Process

Fig 4-1 Installation flowchart

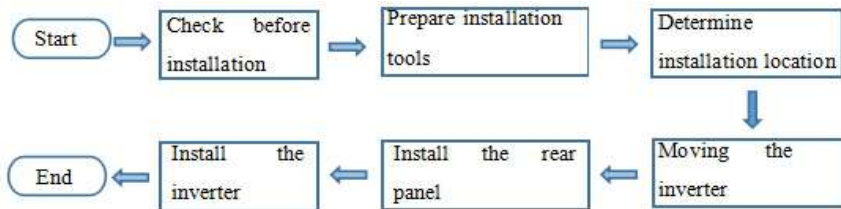

4.2. Checking Before Installation











Checking Outer Packing Materials

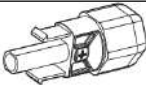
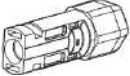







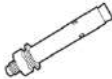

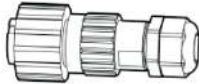

Packing materials and components may be damaged during transportation. Therefore, check the outer packing materials before installing the inverter. Check the outer packing materials for damage, such as holes and cracks. If any damage is found, do not unpack the HYD 5-20KTL-3PH and contact the dealer as soon as possible. You are advised to remove the packing materials within 24 hours before installing the HYD 5-20KTL-3PH inverter.

Checking Deliverables

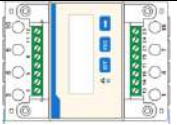
After unpacking the inverter, check whether deliverables are intact and complete. If any damage is found or any component is missing, contact the dealer.

Table4-1 Components and mechanical parts that should be delivered

NO.	Picture	Description	Quantity
1		Inverter	1pcs
2		Rear panel	1pcs
3		PV+ input terminal	4pcs
4		PV- input terminal	4pcs
5		Metal terminals secured to PV+ input power cables	4pcs
6		Metal terminals secured to PV- input power cables	4pcs
7		BAT- input terminal	2pcs
8		BAT+input terminal	2pcs
9		Metal terminals secured to BAT- input power cables	2pcs
10		Metal terminals secured to BAT+ input power cables	2pcs
11		M6 Hexagon screw	2pcs
12		M8*80 Expansion bolts used to secure the wall-mount bracket to the wall	4pcs

13		AC Grid connector	1pcs
14		Load Output connector	1pcs
15		Link port connector	1pcs
16		8 pin terminal Matching terminal resistance (parallel system)	1pcs
17		DRMs connector	1pcs
18		CT 6pin connector	1pcs
19		Three phase electronic energy meter	1pcs
20		Split Core Current Transformer HY94C5-200 (CT to be connected to the DTSU666 Meter only)	3pcs
21		COM 16pin connector	1pcs
22		Manual	1pcs
23		The warranty card	1pcs
24		Quality Certificate	1pcs
25		Outgoing inspection report	1pcs

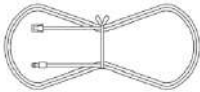
26		M4X14 Cross round head triple set screw (Only for DC switch lock)	1pcs
27		NTC (5M)When using Inner BMS battery, must be connected to NTC	1pcs

4.3. Product Overview

HYD 5-20KTL-3PH inverter is 100% strictly inspected before package and delivery. It is forbidden to put the HYD 5-20KTL-3PH inverter upside down during delivery.

	Please check the product package and fittings carefully before installation.
Caution	

Fig 4-2 HYD 5-20KTL-3PH inverter overview

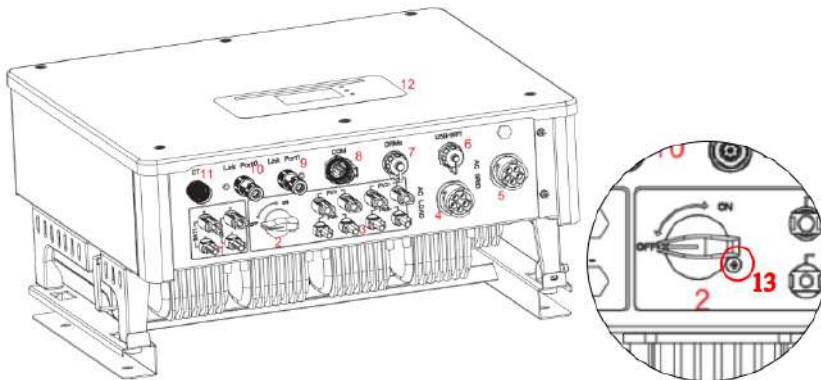

Table 4-2 HYD 5-20KTL-3PH inverter overview

1	Battery input terminals	8	COM
2	DC switch	9	Link Port 1
3	PV input terminals	10	Link Port 0
4	Load connection port	11	CT
5	Grid connection port	12	LCD
6	USB/WiFi	13*	DC switch lock (For Australian models)
7	DRMs		













*Note: Lock the screw to limit the torque of the DC switch, making it impossible to

twist the DC switch from OFF to ON, or ON to OFF. Remove the screw before turning the DC switch from OFF to ON or ON to OFF.

4.4. Tools

Prepare tools required for installation and electrical connections.

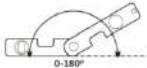
Table 4-3 Tools required for installation and electrical connections.

NO.	Tool	Model	Function
1		Hammer drill Recommend dia. 8mm	Used to drill holes on the wall.
2		Screwdriver	Wiring
3		Cross screwdriver	Remove and install AC terminal screws
4		Removal tool	Remove PV terminal
5		Wire stripper	Strip wire
6		5mm Allen Wrench	Turn the screw to connect rear panel with inverter.
7		Crimping tool	Used to crimp power cables
8		Multi-meter	Used to check grounding
9		Marker	Used to mark signs
10		Measuring tape	Used to measure distances
11		Level	Used to ensure that the rear panel is properly installed
12		ESD gloves	Operators wear
13		Safety goggles	Operators wear

14		Anti-dust respirator	Operators wear
----	---	----------------------	----------------

4.5. Installation Environment

- Choose a dry, clean, and tidy place, convenient for installation.
- Ambient temperature range: $-25^{\circ}\text{C} \sim 60^{\circ}\text{C}$.
- Relative humidity: $0 \sim 100\%$ (non-condensed).
- HYD 5-20KTL-3PH inverter shall be installed in a well-ventilated place.
- No flammable or explosive materials close to HYD 5-20KTL-3PH inverter.
- The AC overvoltage category of HYD 5-20KTL-3PH inverter is category III.
- Maximum altitude: 4000m.

4.6. Determining the Installation Position

Determine an appropriate position for installing the HYD 5-20KTL-3PH inverter. Comply with the following requirements when determining the installation position.

Fig. 4-3 Installation Position of HYD 5-20KTL-3PH inverter

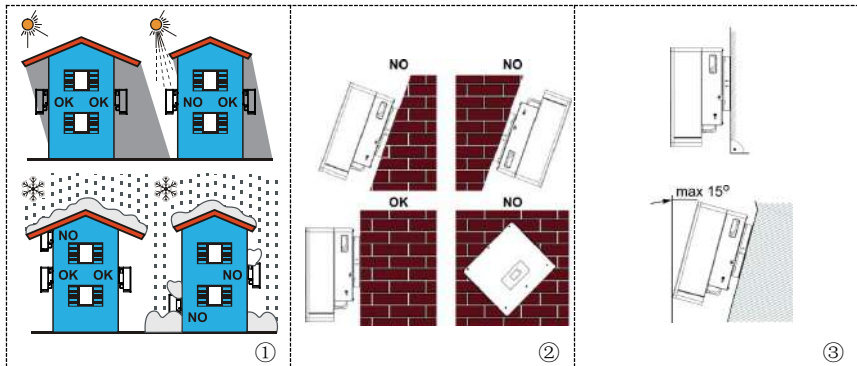

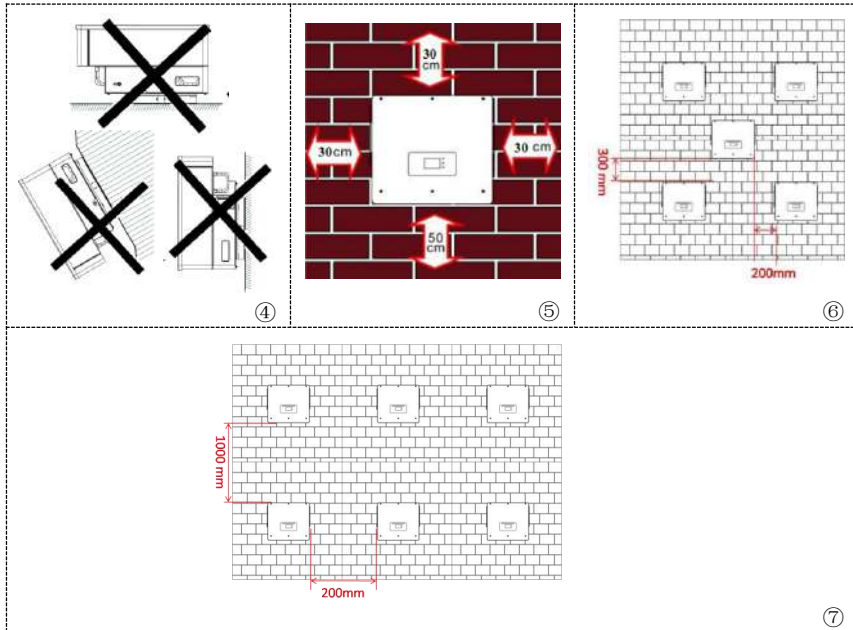



4.7. Moving the HYD 5-20KTL-3PH

Step 1 Open the packaging, insert hands into the slots on both sides of the inverter and hold the handles, as shown in Fig.4-4.

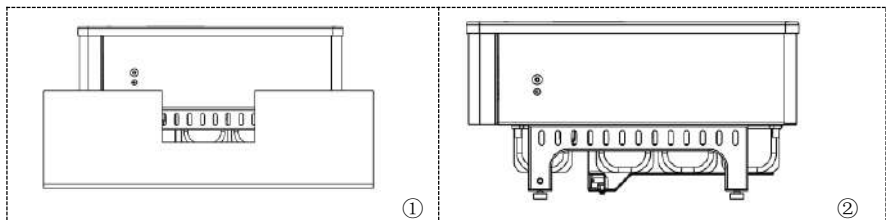
Fig. 4-4 Moving the inverter



Step 2 Lift the inverter from the packing case and move it to the installation position.

 <p>Attention</p>	<p>To prevent device damage and personal injury, keep balance when moving the inverter because the inverter is heavy. Do not put the inverter with its wiring terminals contacting the floor because the power ports and signal ports are not designed to support the weight of the inverter. Place the inverter horizontally. When placing the inverter on the floor, put foam or paper under the inverter to protect its shell.</p>
---	---

4.8. Installing HYD 5-20KTL-3PH

Step 1 Determine the positions for drilling holes, ensure the hole positions are level, then mark the hole positions using a marker pen, use the hammer drill to drill holes on the wall. Keep the hammer drill perpendicular to the wall, do not shake when drilling, so as not to damage the wall. If the error of the hole positions is too big, you need to reposition.

Step 2 Insert the expansion bolt vertically into the hole, pay attention to the insertion depth of the expanding bolt (should be deep enough).

Step 3 Align the rear panel with hole positions, fix the rear panel on the wall by tightening the expansion bolt with the nuts.

Step 4 Hook the inverter to the rear panel. Using an M6 screw to secure the inverter to the rear panel to ensure safety.

Step 5 You can secure the inverter to the rear panel and protect it from stealing by installing an anti-theft lock (this action is optional).

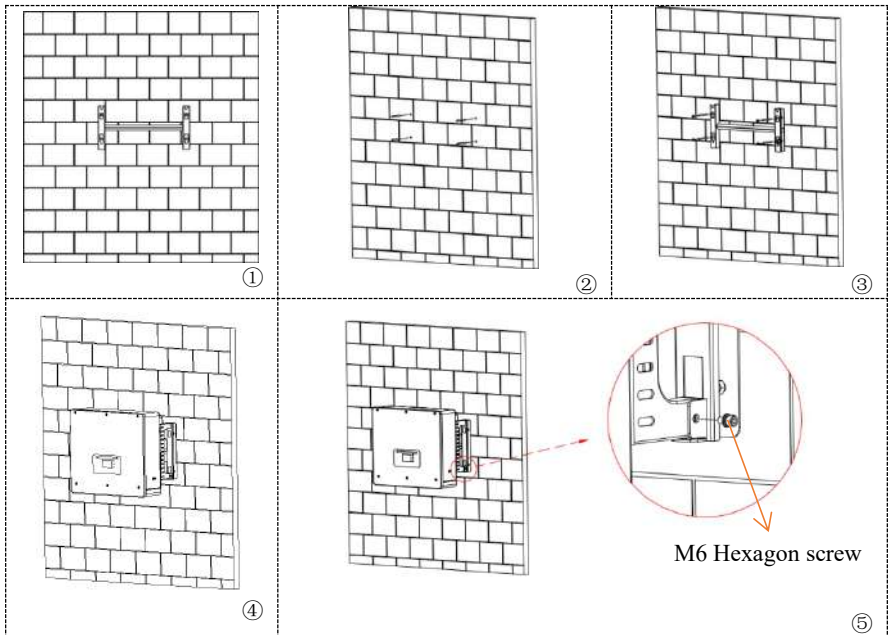

Fig. 4-5 Installing HYD 5-20KTL-3PH



5. Electrical Connections

Before performing electrical connections, ensure that the DC switch is OFF. Since the stored electrical charge remains in a capacitor after the DC switch is turned OFF. So it's necessary to wait for at least 5 minutes for the capacitor to be electrically discharged.

HYD 5-20KTL-3PH inverter is intended to be used in PV system with battery storage. If not used as intended, the protection provided by the equipment may be impaired.

	Installation and maintenance of inverter, must be operated by professional electrical engineer. Wear rubber gloves and protective clothing (protective glasses and boots) when working on high voltage/high current systems such as inverter and battery systems.
Attention	
	PV modules generate electric energy when exposed to sunlight and can create an electrical shock hazard. Therefore, before connecting DC input power cable, cover PV modules using opaque cloth.
Danger	
	For HYD 5-20KTL-3PH, open-circuit voltage (Voc) of module arrays connected in series must be $\leq 1000V$.
Note	

The connected PV modules must have an IEC 61730 Class A rating

Table 5-1 Relevant current parameters of each model

Model	IscPV(absolute maximum)	Maximum output over current protection
HYD 5KTL-3PH	15A/15A	8A*3
HYD 6KTL-3PH		10A*3
HYD 8KTL-3PH		13A*3
HYD 10KTL-3PH	30A/30A	16A*3
HYD 15KTL-3PH		24A*3
HYD 20KTL-3PH		32A*3

NOTE: The DVC is the voltage of a circuit which occurs continuously between any two live part in the worst-case rated operating condition when used as intended.

Table 5-2 The decisive voltage class(DVC)

Interface	DVC
PV input port	DVCC
Grid connection port	DVCC
Battery input port	DVCC
Load connection port	DVCC
USB/WiFi interface	DVCA
COM interface	DVCA
CT interface	DVCA
DRMs	DVCA
Link Port 0 & Link Port 1	DVCA

5.1. Wire instructions

Table 5-3 Cable description

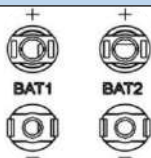
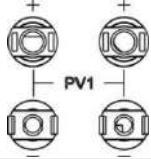
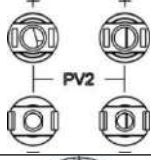
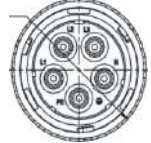
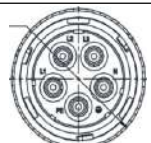
Component	Description	Recommended cable type	Recommended cable specifications	
	+: Connect the positive electrode of lithium battery	Outdoor multi-core copper cable	Conductor cross-sectional area:4mm ² ~6mm ²	
	-: Connect the negative electrode of lithium battery			
	+: Connect the positive electrode of photovoltaic cell	Industry common outdoor photovoltaic cable	Conductor cross-sectional area:4mm ² ~6mm ²	
	-: Connect the negative electrode of photovoltaic cell			
	+: Connect the positive electrode of photovoltaic cell	Industry common outdoor photovoltaic cable	Conductor cross-sectional area:4mm ² ~6mm ²	
	-: Connect the negative electrode of photovoltaic cell			
	Load	L1	Outdoor multi-core copper cable	Conductor cross-sectional area:6mm ² ~10mm ²
		L2		
		L3		
		N		
		PE		
	AC	L1	Outdoor multi-core copper cable	Conductor cross-sectional area:10mm ² ~16mm ²
		L2		
		L3		
		N		
		PE		

Here L1, L2 and L3 correspond to R, S and T in the manual.

5.2. Connecting PGND Cables

Connect the inverter to the grounding electrode using protection ground (PGND) cables for grounding purpose.



Attention

The inverter is transformer-less, requires the positive pole and negative pole of the PV array are NOT grounded. Otherwise it will cause inverter failure. In the PV power system, all non current carrying metal parts (such as: PV module frame, PV rack, combiner box enclosure, inverter enclosure) should be connected to earth.

The PGND cables are prepared ($\geq 4\text{mm}^2$ outdoor power cables are recommended for grounding purposes), the color of cable should be yellow-green.

Procedure:

Step 1 Remove the insulation layer with an appropriate length using a wire stripper, as shown in Fig.5-1.

Step 2 Insert the exposed core wires into the OT terminal and crimp them by using a crimping tool, as shown in Fig.5-1.

Step 3 Install the crimped OT terminal, flat washer using M6 screw, and tighten the screw to a torque of 3 N.m using an Allen wrench.

Note 1: L3 is the length between the insulation layer of the ground cable and the crimped part. L4 is the distance between the crimped part and core wires protruding from the crimped part.

Note 2: The cavity formed after crimping the conductor crimp strip shall wrap the core wires completely. The core wires shall contact the terminal closely.

Fig.5-1 Connecting PGND cable

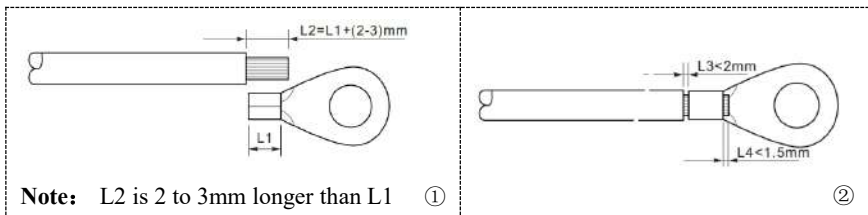

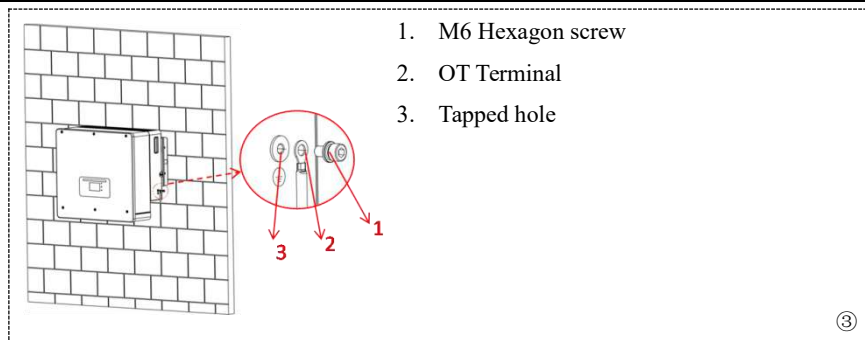

5.3. Battery Connection & PV Connection

The connection mode of Battery connection and PV connection is the same, only the terminal specifications are different. Please correctly correspond when inserting the terminal into the machine end.

Procedure:

Step 1 Select the appropriate cable type and specifications according to the table 5-3. Remove cable glands from the positive and negative connectors. (It is recommended that the positive and negative be distinguished by different colors).

Step 2 Remove the insulation layer with an appropriate length from the positive and negative power cables by using a wire stripper as show in Fig.5-2①.

Step 3 Insert the stripped positive and negative power cables into the positive and negative metal terminals respectively and crimp them using a clamping tool.

Ensure that the cables are crimped until they cannot be pulled out by force less than 400 N, as shown in Fig.5-2②③.

Step 4 Insert crimped power cables into corresponding housings until you hear a "click" sound. The power cables snap into place.

Step 5 Reinstall cable glands on positive and negative connectors and rotate them against the insulation covers.

Step 6 Insert the positive and negative connectors into corresponding Battery&PV terminals of the inverter until you hear a "click" sound, as shown in Fig.5-2⑥.

To remove the positive and negative connectors from the inverter, insert a removal wrench into the bayonet and press the wrench with an appropriate strength, as

shown in Fig.5-2⑦.

	<p>Before removing the positive and negative connectors, ensure that the DC SWITCH is OFF.</p>
<p>Caution</p>	

Fig.5-2 Connect Battery&PV



5.4. Load connection

Procedure:

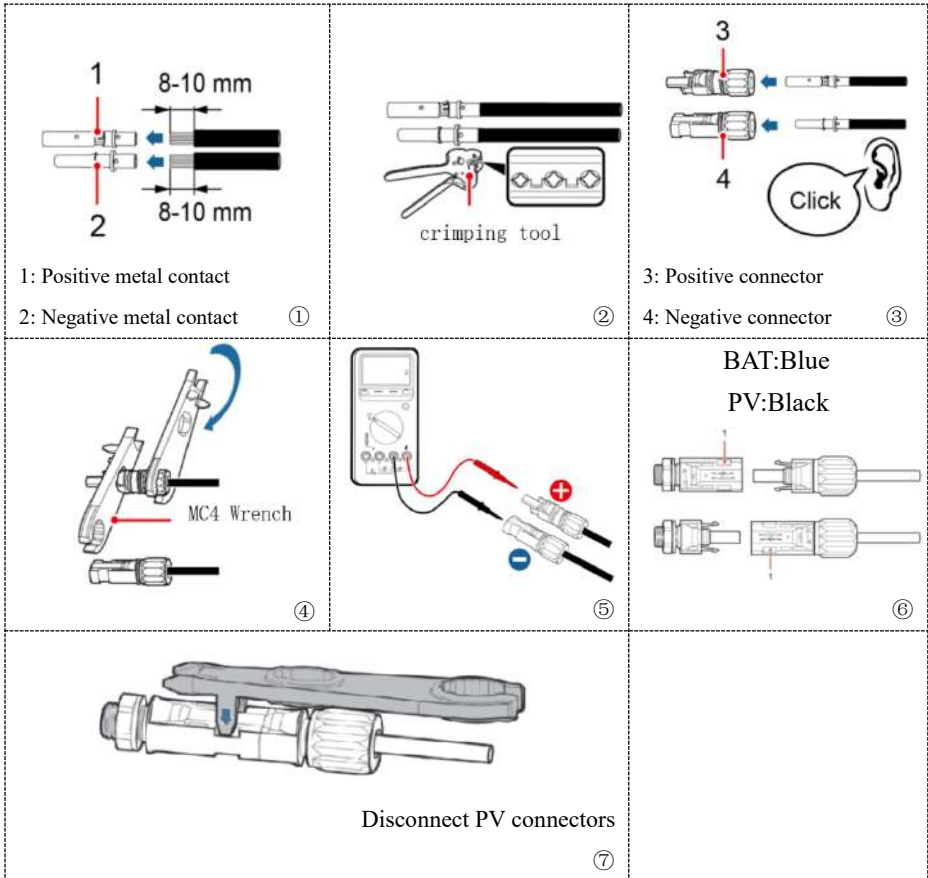
Step 1 Select the appropriate cable type and specifications according to the table 5-3. Refer to Fig.5-3① for processing wire.

Step 2 Pass the wire through the terminal, as shown in Fig.5-3②.

Step 3 Connect the wire to the terminal according to the identification on the terminal, as shown in Fig.5-3③④.

Step 4 Connect the terminal to the machine port and rotate the clamp clockwise.

Fig.5-3 Load connection

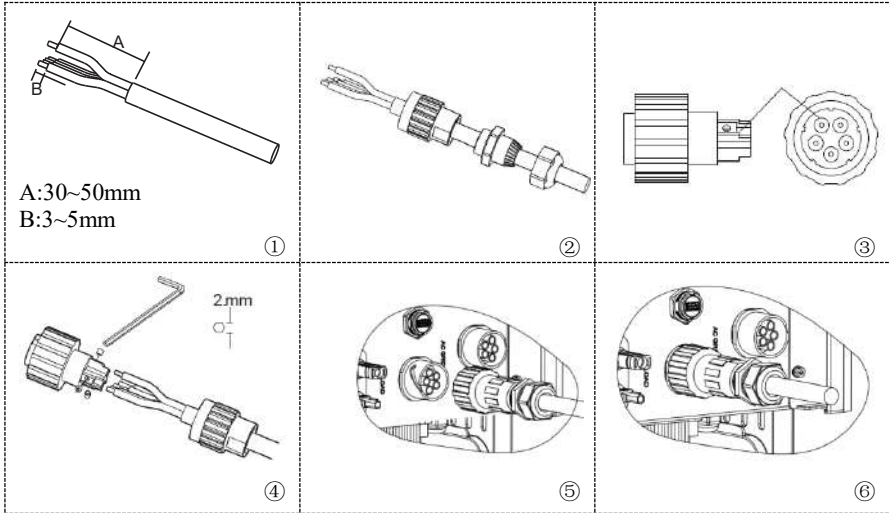

5.5. Grid connection

The inverter is equipped with an integrated residual current monitoring unit. When the inverter detects that the residual current exceeds 100mA, the connection to the power grid will be quickly disconnected.

If the external ac switch has leakage protection function, its rated leakage action current is required to be $\geq 100\text{mA}$.

Procedure:

Step 1 Select the appropriate cable type and specifications according to the table5-3.Refer to Fig.5-4① for processing wire.

Step 2 Pass the wire through the terminal, as shown in Fig.5-4②.

Step 3 Connect the wire to the terminal according to the identification on the terminal, as shown in Fig.5-4③④.

Step 4 Connect the terminal to the machine port and rotate the clamp clockwise.

Fig.5-4 Grid connection

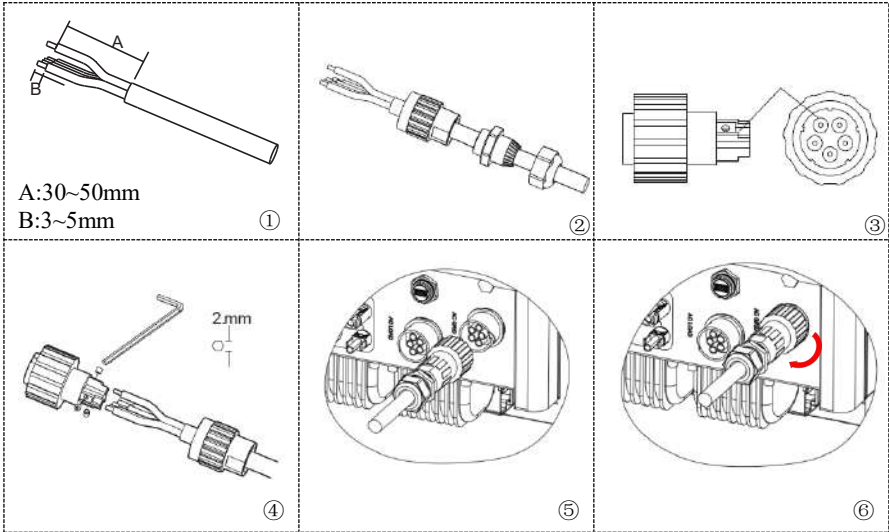

5.6. External communication interface

5.6.1 USB/WIFI communication interface

Fig.5-5 USB/WIFI communication interface

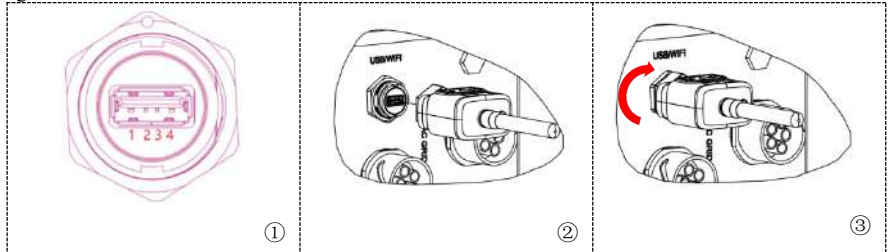
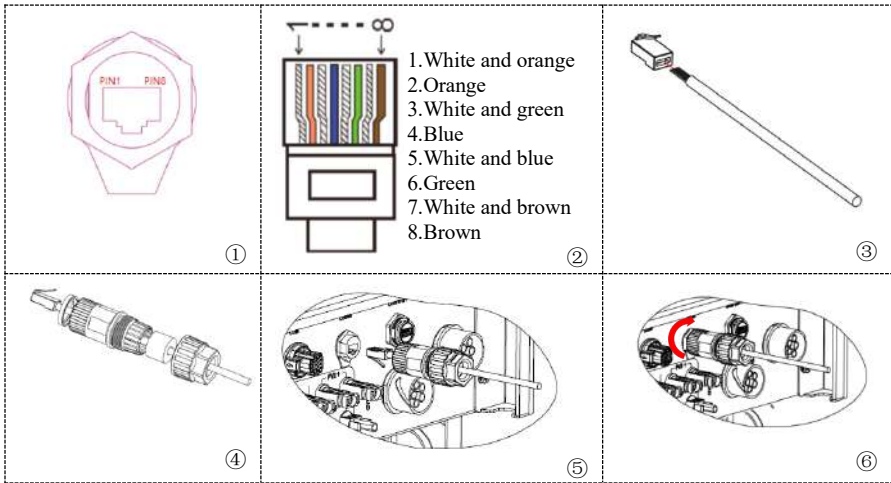

Table5-4 Interface description

PIN	Definition	Function	Note
1	GND.S	USB power -	The USB power supply is 5V/1A; Cannot be used for external device charging
2	DP	USB data +	
3	DM	USB data -	
4	VBUS	USB power +	

5.6.2 DRMs interface- Logic interface

Fig.5-6 Logic interface



Procedure:

Step 1 Press the wire terminals in color sequence.

Step 2 Route Cable terminal through the cable gland, Insert the communication cable into the RJ45 connector.

The logic interface pin definitions and circuit connections are as follows:

Logic interface pin are defined according to different standard requirements

(a) Logic interface for AS/NZS 4777.2:2015, also known as inverter demand response modes (DRMs).

The inverter will detect and initiate a response to all supported demand response commands within 2 s. The inverter will continue to respond while the mode remains asserted.

Table 5-5 Function description of the DRMs terminal

Pin NO.	Color	Function
1	White and orange	DRM1/5
2	Orange	DRM2/6
3	White and green	DRM3/7
4	Blue	DRM4/8
5	White and blue	DRM0
6	Green	RefGen
7	White and brown	Pin7&Pin8 short internal
8	Brown	

(b) Logic interface for VDE-AR-N 4105:2018-11, is in order to control and/or limit the inverter’s output power.

The inverter can be connected to a RRCR (Radio Ripple Control Receiver) in order to dynamically limit the output power of all the inverters in the installation.

Fig.5-7 Inverter – RRCR Connection

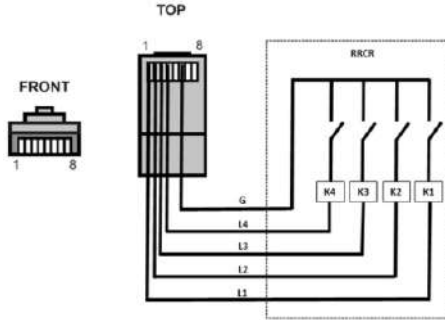

Table 5-6 Function description of the terminal

Pin NO.	Pin name	Description	Connected to (RRCR)
1	L1	Relay contact 1 input	K1 - Relay 1 output
2	L2	Relay contact 2 input	K2 - Relay 2 output
3	L3	Relay contact 3 input	K3 - Relay 3 output
4	L4	Relay contact 4 input	K4 - Relay 4 output
5	NC	Not Connected	Not Connected
6	G	GND	Relays common node
7	NC	Not Connected	Not Connected
8	NC	Not Connected	Not Connected

Table 5-7 The inverter is preconfigured to the following RRCR power levels, close is 1, open is 0

L1	L2	L3	L4	Active Power	Cos(ϕ)
1	0	0	0	0%	1
0	1	0	0	30%	1
0	0	1	0	60%	1
0	0	0	1	100%	1

(c) Logic interface for EN50549-1:2019, is in order to cease active power output within five seconds following an instruction being received at the input interface.

Fig.5-8 Inverter – RRCR Connection

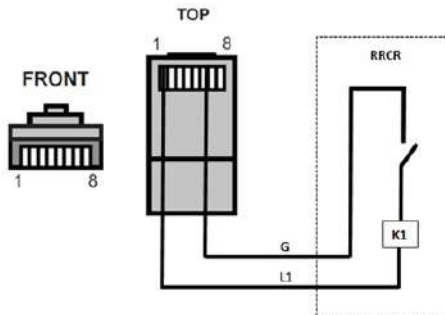

Table 5-8 Function description of the terminal

Pin NO.	Pin name	Description	Connected to (RRCR)
1	L1	Relay contact 1 input	K1 - Relay 1 output
2	NC	Not Connected	Not Connected
3	NC	Not Connected	Not Connected
4	NC	Not Connected	Not Connected
5	NC	Not Connected	Not Connected
6	G	GND	K1 - Relay 1 output
7	NC	Not Connected	Not Connected
8	NC	Not Connected	Not Connected

Table 5-9 The inverter is preconfigured to the following RRCR power levels, close is 1, open is 0

L1	Active Power	Power drop rate	Cos(φ)
1	0%	< 5 seconds	1
0	100%	/	1

5.6.3 COM-Multifunction communication interface

Fig.5-9 COM interface

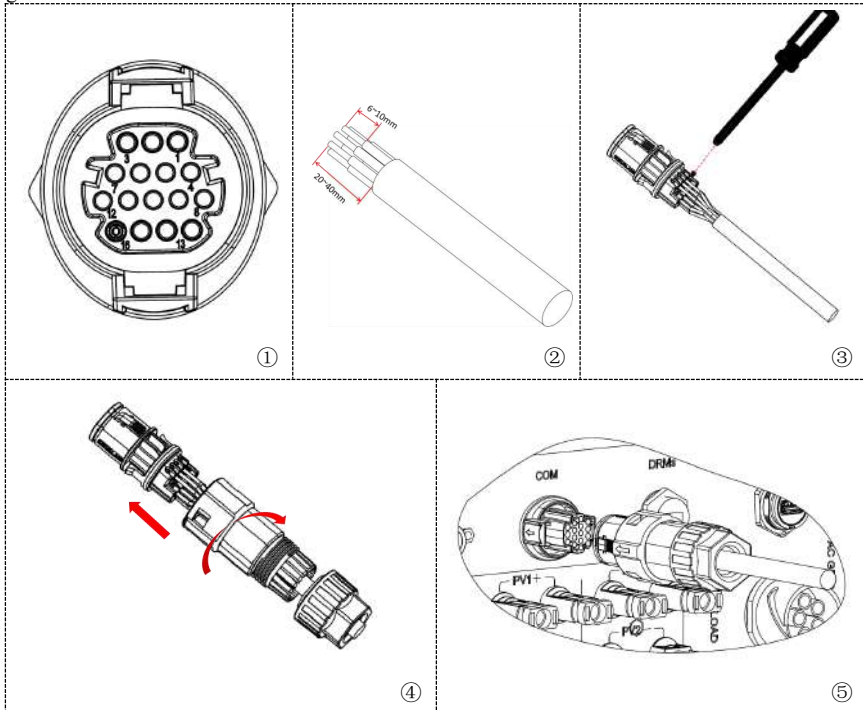

Please refer to the following figure for RS485 connection When you need to use RS485 as a cascade of monitoring between inverters.

Fig.5-10 RS485 connection(cascade of monitoring between inverters)

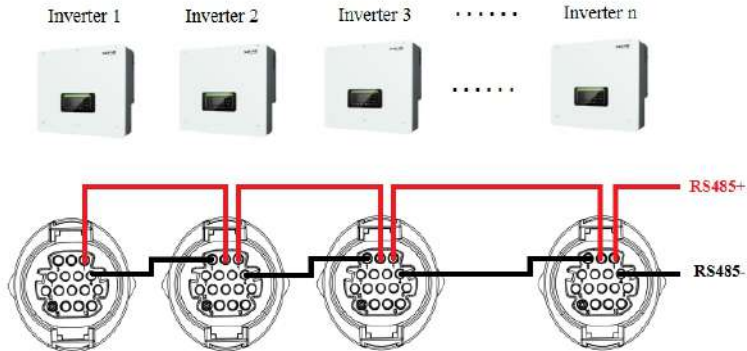

Table 5-10 Interface description

PIN	Definition	Function	Note
1	RS485A1-1	RS485 differential signal +	Wired monitoring or inverter cascade monitoring
2	RS485A1-2	RS485 differential signal +	
3	RS485B1-1	RS485 differential signal -	
4	RS485B1-2	RS485 differential signal -	
5	RS485A2	RS485 differential signal +	Communicate with electricity meters
6	RS485B2	RS485 differential signal -	
7	CAN0_H	CAN high data	Used for communication with lithium battery BMS, the inverter can automatically identify the battery BMS communication as CAN or RS485 communication
8	CAN0_L	CAN low data	
9	GND.S	BMS communication GND	
10	485TX0+	RS485 differential signal +	
11	485TX0-	RS485 differential signal -	Inner BMS battery temperature sampling
12	GND.S	Signal GND	
13	BAT Temp	Battery temperature sampling	Providing electrical switching function
14	DCT1	Dry Contact1	
15	DCT2	Dry Contact2	
16	VCC	Communication VCC	12V power supply

PIN5 and PIN6 are used for meter communication, the electricity meter is shown in the Fig.5-11①, PIN5 and PIN6 correspond to 24,25 respectively on the electricity meter, as shown in Fig.5-11③.

The connection mode is shown in Fig.5-11②. The 2,5,8 and 10 on the electricity meter are connected to voltage signals A,B,C and N respectively.

And the current needs to be connected through the current transformer,1,3 correspond to the A-phase current transformer, 4,6 correspond to the B-phase, 7,9 correspond to the C-phase.

NOTE:The direction of the current transformer is shown in Fig.5-11④.

Fig.5-11 Meter

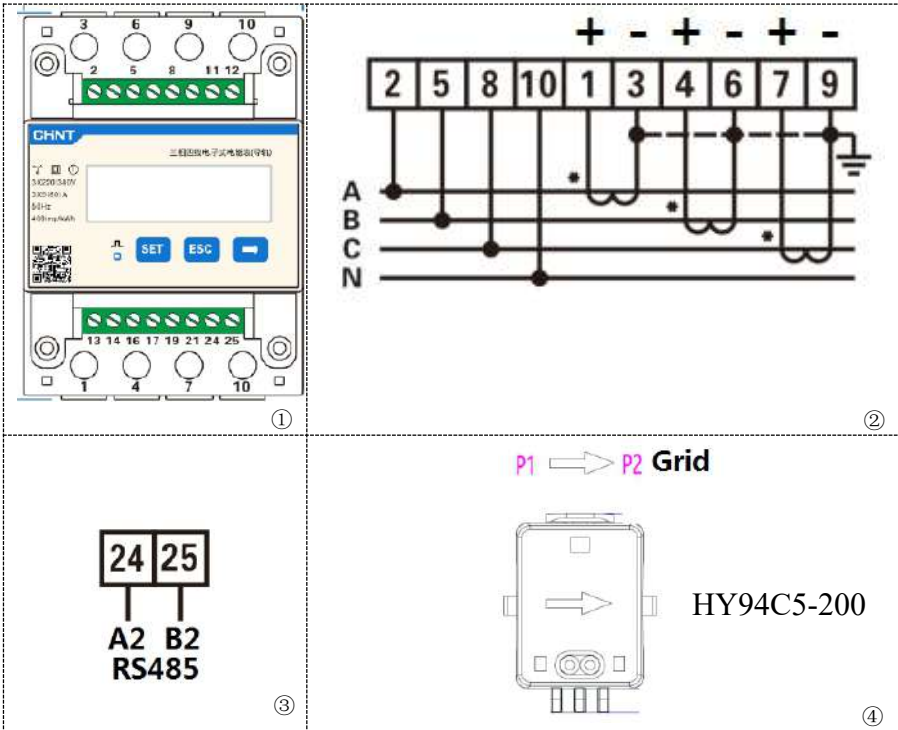

5.6.4 Link Port 0&1-Cascade communication interface

Fig.5-12 Link Port

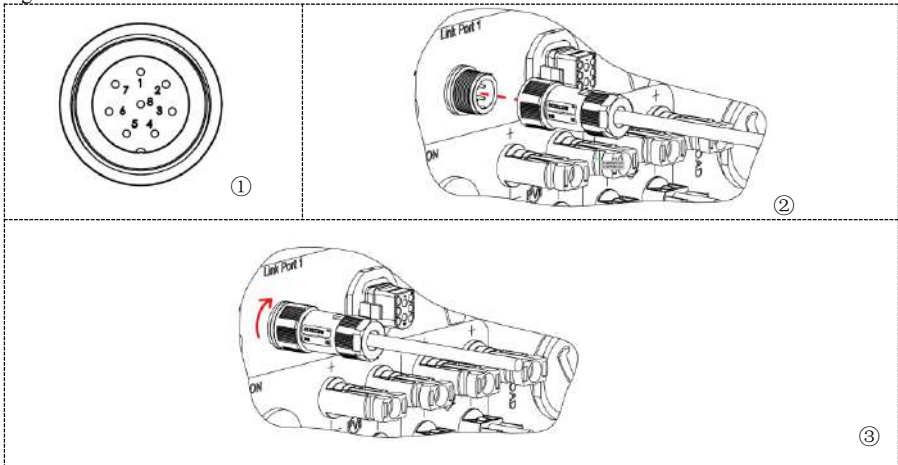

When using the parallel system, the inverter settings and notes please refer to this manual<6.3.2 Advanced setting→6.Parallel setting>.

NOTE(AC LOAD is also parallel for parallel system):

- 1.The first and last inverters need to be connected to the 8Pin terminal.
- 2.It is recommended that the AC LOAD output wiring of all machines converge together and connect to the LOAD through the AC circuit breaker. It is not recommended that each machine connect the AC circuit breaker to the LOAD separately. Avoid the disconnection of the AC circuit breaker connected by a single machine, and the power distributed to other machines exceeds the allowable maximum load power of a single machine.
- 3.It is recommended that the AC Grid output wiring of all machines should converge together and be connected to the power GRID through the AC circuit breaker. It is not recommended that each machine connect the AC circuit breaker to the power GRID separately, because when the AC circuit breaker connected by a single machine is disconnected, the AC Grid end of the machine still has AC power, so as to avoid electric shock caused by misjudgment of the operator.
- 4.The cable length from the LOAD end to the AC LOAD end of each machine needs to be consistent with the wire length specification to ensure that the circuit impedance is consistent and the LOAD current shunt to each machine is close to the same.
- 5.When the LOAD power is greater than the maximum allowable AC LOAD power of parallel machine system (for example, the maximum allowable AC LOAD power of one 20kW machine is 22kVA, and the maximum allowable AC LOAD power of five parallel machines is 110kVA), the LOAD cannot be connected to the AC LOAD terminal, but needs to be connected to the AC GRID terminal.
- 6.The working state of all machines in the parallel machine system must be consistent.
- 7.The main AC switch must be turned off during machine maintenance.

Fig.5-13 parallel system

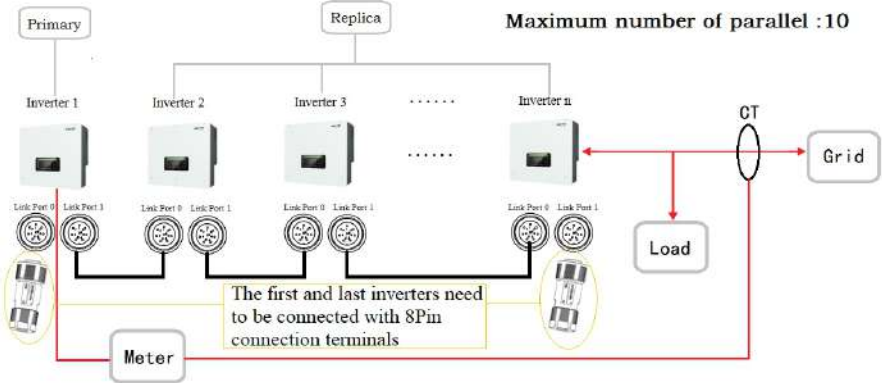

Table 5-11 Interface description

PIN	Definition	Function	Note
1	IN_SYN0	Synchronizing signal0	The high level of the synchronous signal is 12V
2	CANL	CAN low data	
3	SYN_GND0	Synchronizing signal GND0	
4	CANH	CAN high data	
5	IN_SYN1	Synchronizing signal1	
6	SYN_GND1	Synchronizing signal GND1	
7	SYN_GND2	Synchronizing signal GND2	
8	IN_SYN2	Synchronizing signal2	

5.6.5 CT-External current sensor interface

Table 5-12 Interface description

PIN	Definition	Function	Note
1	Ict_R-	The current sensor outputs a negative electrode	Used to connect R phase current sensor of power grid
2	Ict_R+	The current sensor outputs a positive electrode	
3	Ict_S-	The current sensor outputs a negative electrode	Used to connect S phase current sensor of power grid
4	Ict_S+	The current sensor outputs a positive electrode	
5	Ict_T-	The current sensor outputs a negative electrode	Used to connect T phase current sensor of power grid
6	Ict_T+	The current sensor outputs a positive electrode	

Fig.5-14 CT interface

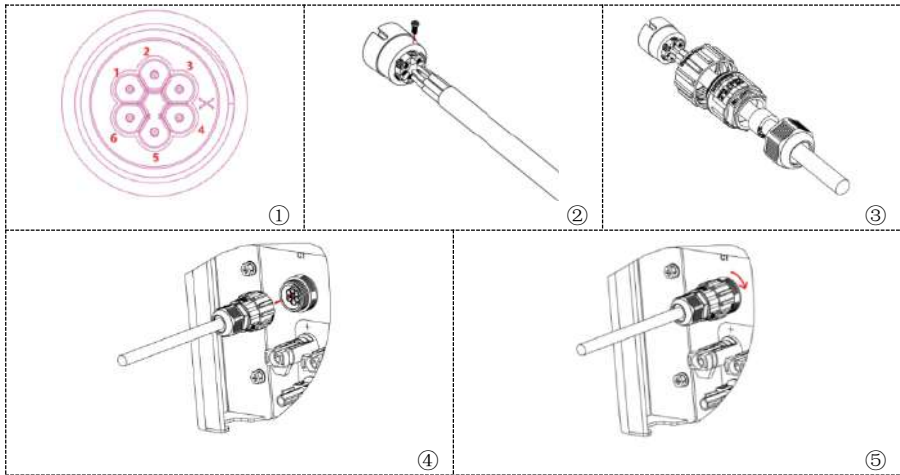

There are two ways to get grid current information :

Plan A:CT Plan B:Meter +CT(default)

The system with the current per phase less than 300A can be directly connected to CT or electricity meter. Above 300A, only electricity meters can be used.

There are two situations when CT is installed. One is to connect in the correct CT direction. The direction should refer to the figure below, from the inverter to the power grid. One is the random CT direction, and then the use of CT calibration function for calibration. CT calibration procedures refer to this manual 7.3.2>>8.CT calibration.

If the Main Switch is used residual current protection device, it is recommended to choose type A protector for RCD with leakage current of 100mA or above (it is better to adjust according to the size of the system).

The inverter output of HYD 5-20KTL-3PH series inverter has 4 sets of relays, which are electrically connected to the output end R/S/T/N respectively to ensure the continuity of the electrical connection of load R/S/T/N when the inverter is switched off the grid.

Fig. 5-15 Electrical connections (Plan A:CT)

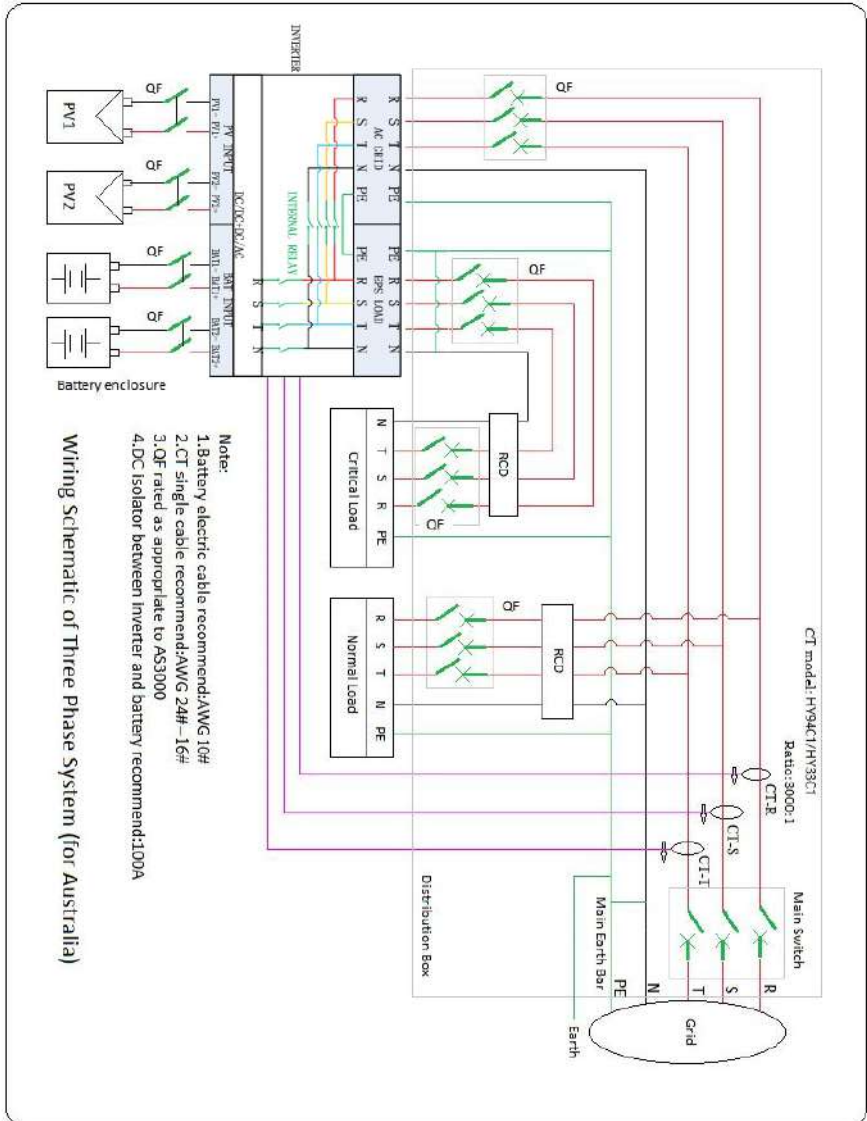
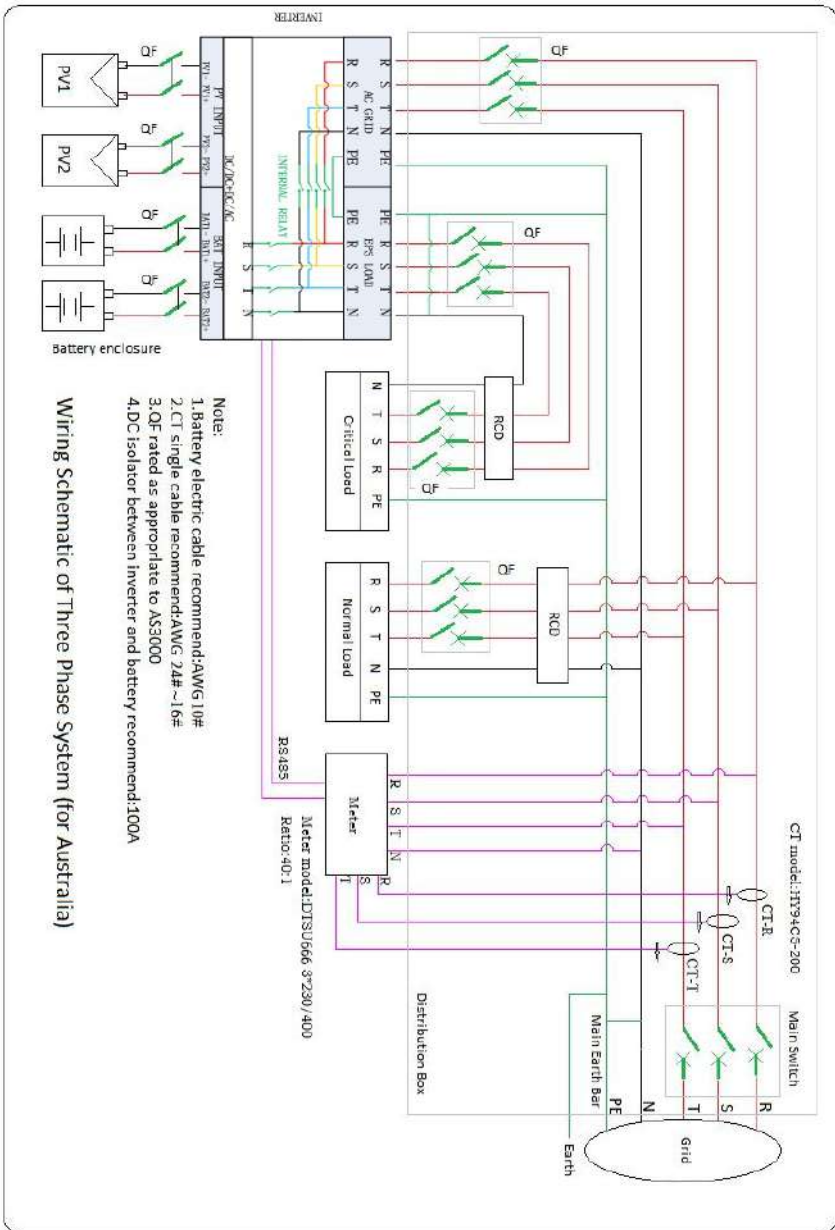

Fig. 5-16 Electrical connections (Plan B: Meter + CT)



5.7. Communication method

HYD 5-20KTL-3PH offer RS485 (standard) and WiFi/GPRS (optional) communication modes:

A. Single inverter communication :

1. RS485

Refer to the figure shown below, connect the RS485+ and RS485- of the inverter to the TX+ and TX- of the RS485 → USB adapter, and connect the USB port of the adapter to the computer.(NOTE : The length of the RS485 communication cable should be less than 1000 m)

Fig 5-17



If you need to use upper computer software, please consult the after-sale technical support personnel of SOFAR SOLAR.The upper computer software can be used to set the enabling and parameter of power control, over and under voltage load shedding parameters, over and under frequency shedding parameters, and reactive power output enabling and parameter setting.

Open SolarMonitor,Follow the Fig5-18 to enter the page.

Fig 5-18

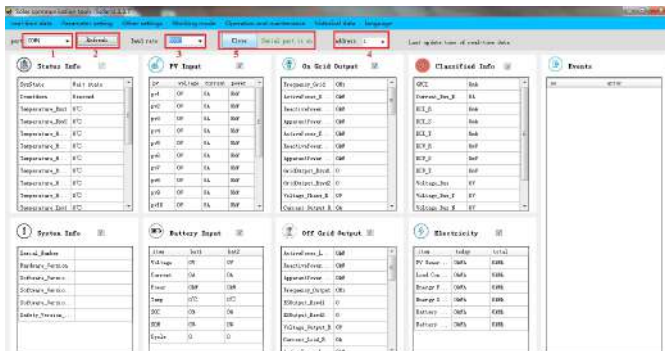

-Volt-Var response modes

Fig 5-19

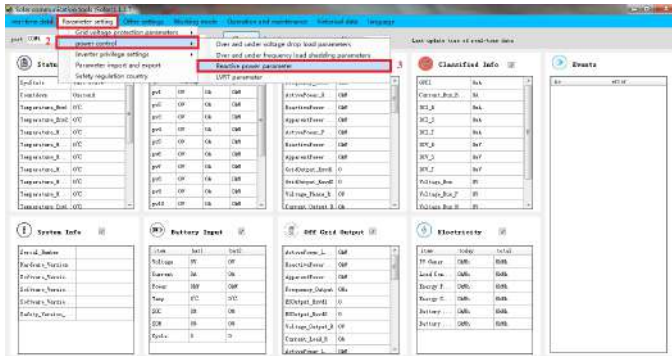
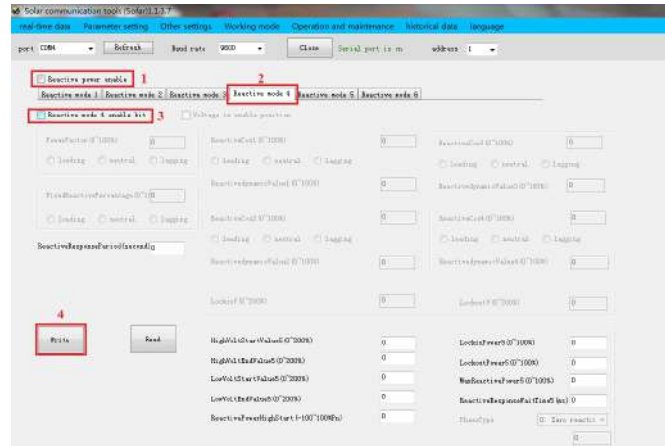

Fig 5-20



-Volt-watt response mode

Fig 5-21

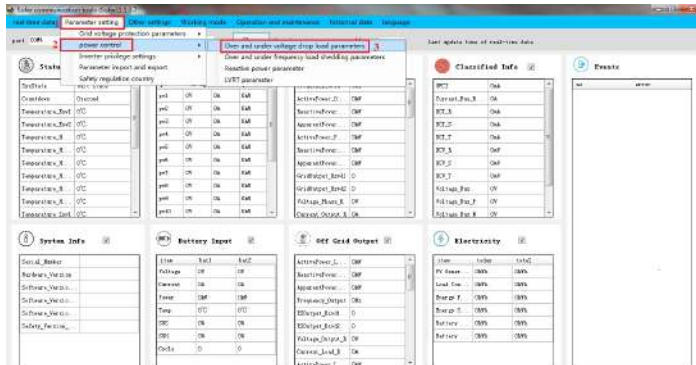
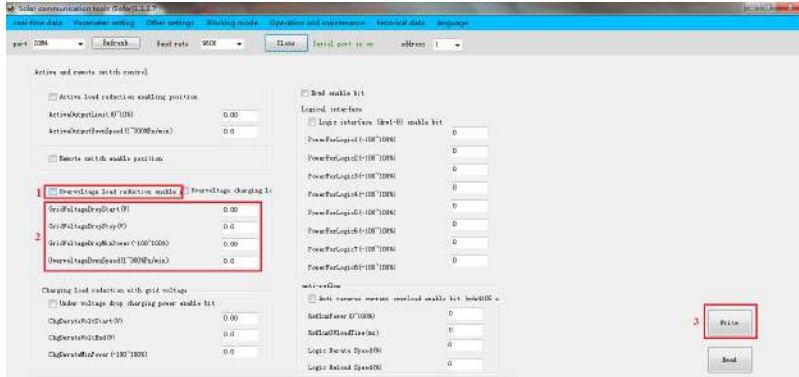

Fig 5-22



Note:After setting the parameters to be set, be sure to click write to save the content.

2. WiFi/GPRS

Refer to the figure shown below.

Fig 5-23

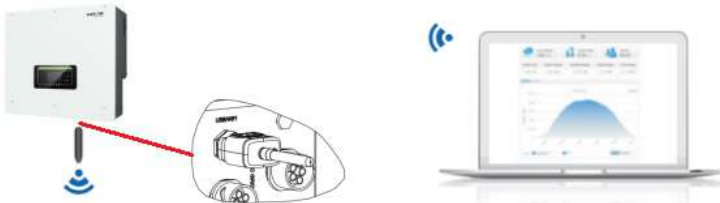

The operation information (generated energy, alert, operation status) of the inverter can be transferred to PC or uploaded to the server via WiFi/GPRS. Users can choose to use web or APP for monitoring and viewing according to their needs. They need to register an account and bind the device with the WiFi/GPRS SN number. The SN number of the WiFi/GPRS shall be affixed to the package box and the WiFi/GPRS. Web: <https://home.solarmanpv.com> (Recommended browser: Chrome58, Firefox49, IE9 and above version) .

APP: Android: Go to Android Market and search “SolarMAN”.

IOS: Go to App Store and search “SolarMAN”.

SolarMAN-3.0-Web User Manual, Please visit the <https://doc.solarmanpv.com/web/#/7>.

SolarMAN-App User Manual, Please visit the <https://doc.solarmanpv.com/web/#/14>.

B. Communication between multiple inverters :

1. RS485

RS485 wires are connected in parallel between inverters, Connect the RS485+ and RS485- of the inverter to the TX+ and TX- of the RS485 → USB adapter; connect the USB port of the adapter to the computer. (NOTE: When multiple inverters are connected via RS485 wires, set communication address to differentiate the inverters , please refer to this manual<7.3.1System setting→8.Communication Addr>)

Note:An isolated adapter must be used or the signal will be interfered.

Fig 5-24

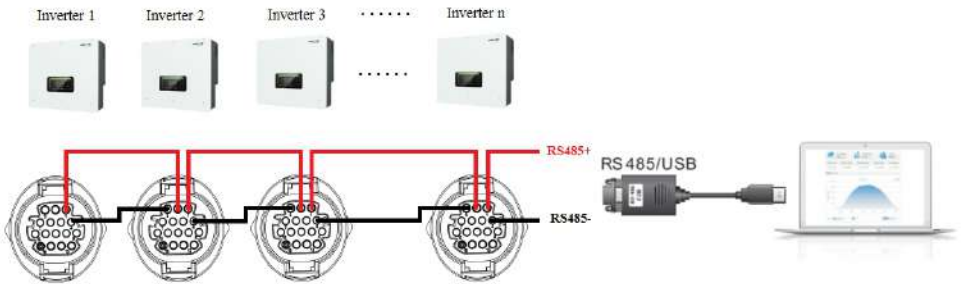

2. WI-FI/GPRS

Refer to the figure shown below, the monitoring mode is the same as that of a single unit.

Fig 5-25



6. Buttons and indicator lights

Fig.6-1 Buttons and indicator lights

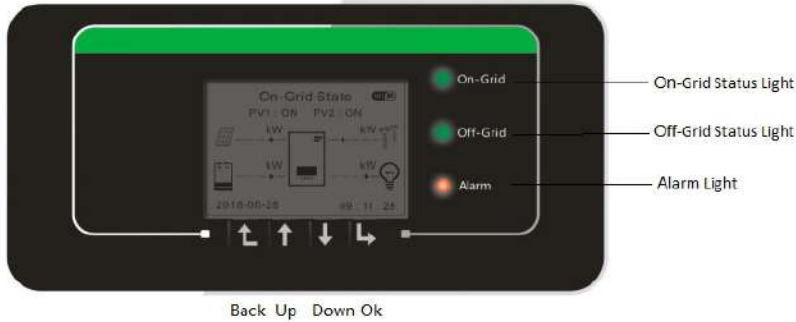

6.1. Buttons

- ✧ press “Back” to the previous screen or enter the main interface.
- ✧ press “Up” to the upper menu option or value plus 1.
- ✧ press “Down” to the lower menu option or value minus 1.
- ✧ Press “OK” to select the current menu option or switch to the next digit.

6.2. Indicator lights and status

Status	On Grid Green light	Off-Grid Green light	Alarm Red light
On-grid	ON		
Standby (On-Grid)	Flashing		
Off-Grid		ON	
Standby (Off-Grid)		Flashing	
Alarm			ON

7. Operation (commission)

7.1. Double Check

Please double check the following before operation.

1. Inverter is firmly fastened to the mounting bracket on the wall.
2. PV+/PV- wires are firmly connected, polarity and voltage are correct.
3. BAT+/BAT- wires are firmly connected, polarity and voltage are correct.
4. DC isolator is correctly connected between battery & inverter, DC isolator OFF.
5. GRID / LOAD cables are firmly / correctly connected.
6. AC circuit breaker is correctly connected between inverter GRID port & GRID, circuit breaker: OFF.
7. AC circuit breaker is correctly connected between inverter LOAD port & critical load, circuit breaker: OFF.
8. For lithium battery, please ensure that the communication cable has been correctly connected.
9. For the lead-acid battery, please ensure that the NTC wire has been correctly connected.

7.2. First Time Setup (IMPORTANT!)

IMPORTANT: Please follow the following procedure to switch ON inverter.

1. Make sure there's no power generation in inverter's phase.
2. Turn ON DC switch.
3. Switch ON the battery. Turn ON DC isolator between battery & inverter.
4. Turn ON AC circuit breaker between the inverter GRID port & GRID.
5. Turn ON AC circuit breaker between the inverter LOAD port & critical load.
6. Inverter should start to operate now.

You need to set the following parameters before inverter starts to operate.

Table 7- 1 Set the parameters

Parameter	Note
1.OSD Language Option	The default English.
2.System time setting and confirmation	If you are connected to the host computer such as collector or mobile phone APP, the time should have been calibrated to the local time.
*3.Safety parameter import	You need to find the safety parameters file (named after the corresponding safety country) on the website, download it to the usb flash drive, and import it.
4.Set the input channel	Default order: BAT1, BAT2, PV1, PV2
*5.Set battery parameters	Default values can be displayed according to the input channel configuration.
6. Setup is complete	

Table 7-2 List of regulated countries

Code	Country	Code	Country
000	000* Germany VDE4105	018	000 EU EN50438
	001 Germany BDEW		001* EU EN50549
	002* Germany VDE0126	019	000 IEC EN61727
001	000 Italia CEI-021 Internal	020	000 Korea
	001* Italia CEI-016 Italia	021	000 Sweden
	002* Italia CEI-021 External	022	000 Europe General
	003 Italia CEI0-21 In Areti	024	000 Cyprus
002	000 Australia	025	000 India
	001 Australia AU-WA	026	000 Philippines
	002* Australia AU-SA	027	000 New Zealand
	003 Australia AU-VIC	028	000 Brazil
	004 Australia AU-QLD		001 Brazil LV
	005 Australia AU-VAR		002 Brazil 230
	006 Australia AUSGRID		003 Brazil 254
	007 Australia Horizon	029	000* Slovakia VSD
003	Spain RD1699		001* Slovakia SSE
004	000* Turkey		002* Slovakia ZSD
005	000 Denmark	033	000* Ukraine
	001 Denmark TR322	035	000 Mexico LV
006	000* Greece Continent	038	000 Wide-Range-60Hz
	001* Greece island	039	000* Ireland EN50438
007	000* Netherland	040	000 Thailand PEA
008	000* Belgium		001 Thailand MEA
009	000 UK G59/G99	042	000 LV-Range-50Hz
	001 UK G83/G98	044	000 South Africa
010	000 China	046	000* Dubai DEWG
	001 China Taiwan		001 Dubai DEWG MV

011	000*	France	107	000*	Croatia
	001	France FAR Arrete23	108	000*	Lithuania
012	000	Poland			

*Note:The national safety regulation enables the function of low pressure through by default, so the off-grid conversion time is greater than 20ms.

	<p>It's very important to make sure that you have selected the correct country code according to requirements of local authority. Please consult qualified electrical engineer or personnel from electrical safety authorities about this.</p> <p>Shenzhen SOFARSOLAR Co., Ltd. is not responsible for any consequences arising out of incorrect country code selection.</p>
Caution	

*5.Set battery parameters (Take the default input channel configuration as an example).Start with battery 1 and work your way up to battery n.

Battery Type		
	Type of band communication protocol	Lead acid or no protocol type
	1.Battery Address	1.Battery Capacity
	2.Battery Charge Current Limit	2.Battery Nominal Voltage
	3.Battery Discharge Current Limit	3.Battery Cell Type
	4.Battery DOD	4.Battery Charge Current Limit
		5.Battery Discharge Current Limit
		6.Battery DOD

Table 7-2 Default values for other Settings

Item	The default state
Energy Storage Mode	Self-use mode
EPS Mode	Disable
Anti Reflux	Disable
IV Curve Scan	Disable
Logic interface	Disable

7.3. Menu

Fig 7-1. Main interface

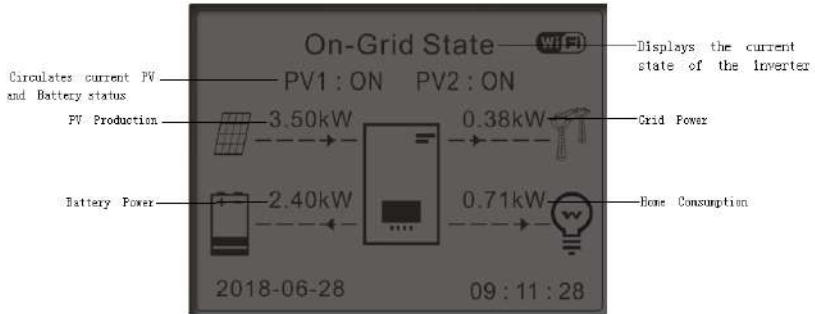

In the main interface, press “Down” button to enter grid/battery parameters page.

Main interface	Down↓	Grid Output Information
		Grid(V) R.....***.*V
		Grid(V) S.....***.*V
		Grid(V) T.....***.*V
		AC Current R.....**.*A
		AC Current S.....**.*A
		AC Current T.....**.*A
		Frequency.....**.*Hz
	Down ↓	Battery Information (1)
		Batt1 (V).....***.*V
		Batt1 Curr.....**.*A
		Batt1 Power.....**.*KW
		Batt1 Temp.....*°C
		Batt1 SOC.....**0%
		Batt1 SOH.....**0%
		Batt1 Cycles.....*T
	Down↓	Battery Information (2)
		Batt2 (V).....***.*V
		Batt2 Curr.....**.*A
		Batt2 Power.....**.*KW
		Batt2 Temp.....*°C
		Batt2 SOC.....**0%
		Batt2 SOH.....**0%
		Batt2 Cycles.....*T

In the main interface, press “UP” button to enter PV parameters page.

Main interface	Up↑	PV Information
		PV1 Voltage.....***.*V
		PV1 Current.....**.*A
		PV1 Power.....**.*KW
		PV2 Voltage.....***.*V

PV2 Current.....	**.**A
PV2 Power.....	**.**KW
Inverter Temp.....	*°C

In the main interface, press “back” button to enter main menu. The main menu has the following six options.

Main interface	Back	1.System Setting
		2.Advanced Setting
		3.Energy Statistic
		4.System Information
		5.Event List
		6.Software Update

7.3.1 System setting

1. System Setting	OK	1.Language Settings
		2.Time
		3.Safety Param.
		4.Energy Storage Mode
		5.Auto Test(Only for Italy)
		6.Input Channel Config
		7.EPS Mode
		8.Communication Addr.

1. Language Settings
Used to set the menu display language.

1.Language Settings	OK	1. 中文	OK
		2.English	
		3.Italiano	
		4.	
		

2. Time
Set the system time for the inverter.

2.Time	OK	Time
		2020-05-13 17:07:00

3. Safety Param
User can modify the Safety Param of the machine through the usb flash disk, and the user needs to copy the parameter information that needs to be modified into the usb flash disk card in advance.

Note: To enable this feature, please contact the Sofarsolar technical support .

4. Energy Storage Mode

4. Energy Storage Mode

OK

1. Self-use Mode

OK

2. Time-of-use Mode

3. Timing Mode

4. Passive Mode

OK

Self-use Mode

In Self-use mode, inverter will automatically charge & discharge the battery.

- 1) If PV generation = LOAD consumption ($\Delta P < 100W$) inverter won't charge or discharge the battery.

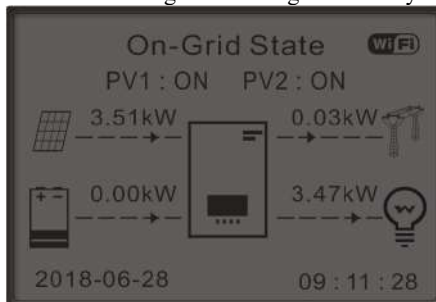

- 2) If PV generation > LOAD consumption, the surplus power will be stored in the battery.

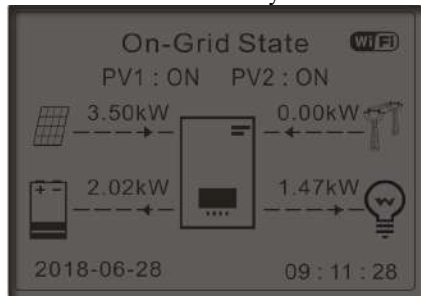

- 3) If the battery is full (or already at Max Charge Power), excess power will be exported to the grid.

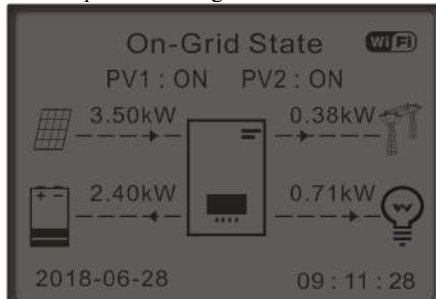

- 4) If PV generation < LOAD consumption, it will discharge the battery to supply power to load.

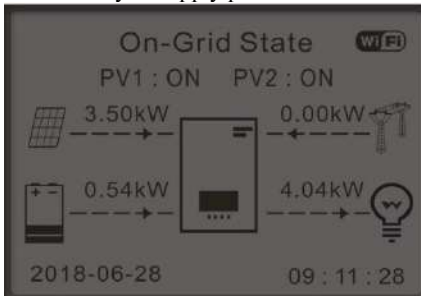

- 5) If PV generation + Battery < LOAD consumption, inverter will import power from the grid.

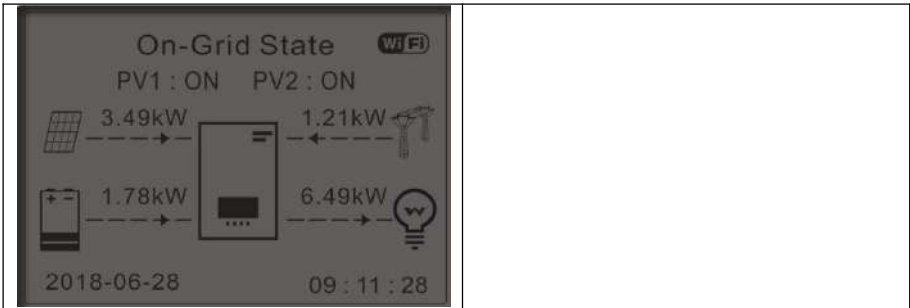

Power Supply Priority Level: PV power > battery > grid



Power Consumption Priority Level: Load > battery > grid

Note: If it is not allowed to export power to grid, a Anti Reflux Meter/CT needs to be installed, and “Anti Reflux Control” function needs to be enabled. For details, please refer to wiring diagram on page 30-32 of this manual and setting method in Section 7.3.2.

Time-of-use Mode

If electricity is more expensive in high demand time (peak rate) & electricity is much cheaper in low demand time (off-peak rate).

You can select an off-peak period to charge your battery. Outside the off-peak charge period, inverter is working in Auto Mode.

If your family normally go to work/school on weekdays & stay at home on weekends, which means the home electricity consumption is much higher on weekends. Thus, you need to store some cheap electricity on weekends only. This is possible using our Time-of-use mode.

In summer, if your PV system can produce more electricity than your home electricity consumption. Then you don't need to set an off-peak charge period to charge your battery in summer at all. You can select an effective date (normally winter) for Time-of-use mode in this case. Outside the effective date, inverter is working in Auto Mode.

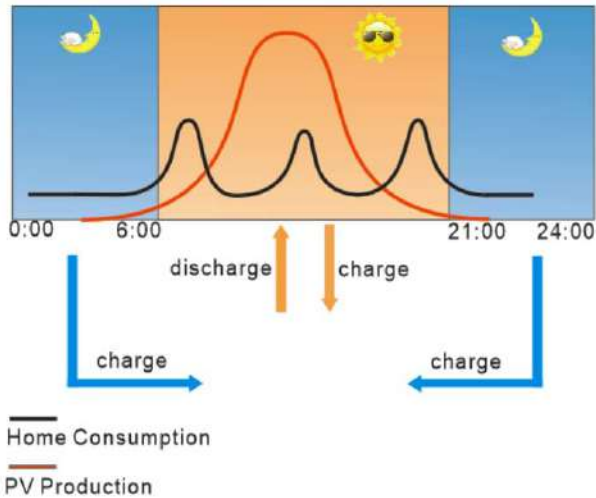

You can set multiple Time-of-use rules to meet your more complex requirement. Right now we support 4 rules maximum (rule 0/1/2/3).

2. Time-of-use Mode

OK

Set Time-of-use Mode			
Rules. 0:	Enabled/Disabled		
From	To	SOC	Charge
02h00m	- 04h00m	070%	01000W
Effective date			
Dec. 22	-	Mar. 21	
Weekday	select		
Mon.	Tue.	Wed.	Thu.
Fri.	Sat.	Sun.	

Set Timing Mode

Changing the value of a rule can set multiple timing rules.

3.Timing Mode	OK	<table border="1"> <tr><td>Timing Mode</td><td></td></tr> <tr><td>Rules. 0:Enabled/Disabled</td><td></td></tr> <tr><td>Charge Start</td><td>22 h 00 m</td></tr> <tr><td>Charge End</td><td>05 h 00 m</td></tr> <tr><td>Charge Power</td><td>02000 W</td></tr> <tr><td>DisCharge Start</td><td>14 h 00m</td></tr> <tr><td>DisCharge End</td><td>16 h 00m</td></tr> <tr><td>DisCharge Power</td><td>02500 W</td></tr> </table>	Timing Mode		Rules. 0:Enabled/Disabled		Charge Start	22 h 00 m	Charge End	05 h 00 m	Charge Power	02000 W	DisCharge Start	14 h 00m	DisCharge End	16 h 00m	DisCharge Power	02500 W
Timing Mode																		
Rules. 0:Enabled/Disabled																		
Charge Start	22 h 00 m																	
Charge End	05 h 00 m																	
Charge Power	02000 W																	
DisCharge Start	14 h 00m																	
DisCharge End	16 h 00m																	
DisCharge Power	02500 W																	

Passive Mode

For more detailed information, please ask representative of SOFAR to get a copy of passive mode communication protocol.



5. Auto Test (ONLY for Italian Market)

5.Auto Test	OK	<table border="1"> <tr><td>1.Autotest Fast</td></tr> <tr><td>2.Autotest STD</td></tr> </table>	1.Autotest Fast	2.Autotest STD
1.Autotest Fast				
2.Autotest STD				

Autotest Fast

1. Autotest Fast	OK	<table border="1"> <tr><td>Start Autotest</td><td>Press "Ok" to start</td></tr> <tr><td>Testing 59.S1...</td><td></td></tr> <tr><td>↓</td><td>Wait</td></tr> <tr><td>Test 59.S1 OK!</td><td></td></tr> <tr><td>↓</td><td>Wait</td></tr> <tr><td>Testing 59.S2...</td><td></td></tr> <tr><td>↓</td><td>Wait</td></tr> <tr><td>Test 59.S2 OK!</td><td></td></tr> <tr><td>↓</td><td>Wait</td></tr> <tr><td>Testing 27.S1...</td><td></td></tr> <tr><td>↓</td><td>Wait</td></tr> <tr><td>Test 27.S1 OK!</td><td></td></tr> <tr><td>↓</td><td>Wait</td></tr> <tr><td>Testing 27.S2...</td><td></td></tr> <tr><td>↓</td><td>Wait</td></tr> <tr><td>Test 27.S2 OK!</td><td></td></tr> <tr><td>↓</td><td>Wait</td></tr> <tr><td>Testing 81>S1...</td><td></td></tr> </table>	Start Autotest	Press "Ok" to start	Testing 59.S1...		↓	Wait	Test 59.S1 OK!		↓	Wait	Testing 59.S2...		↓	Wait	Test 59.S2 OK!		↓	Wait	Testing 27.S1...		↓	Wait	Test 27.S1 OK!		↓	Wait	Testing 27.S2...		↓	Wait	Test 27.S2 OK!		↓	Wait	Testing 81>S1...	
Start Autotest	Press "Ok" to start																																					
Testing 59.S1...																																						
↓	Wait																																					
Test 59.S1 OK!																																						
↓	Wait																																					
Testing 59.S2...																																						
↓	Wait																																					
Test 59.S2 OK!																																						
↓	Wait																																					
Testing 27.S1...																																						
↓	Wait																																					
Test 27.S1 OK!																																						
↓	Wait																																					
Testing 27.S2...																																						
↓	Wait																																					
Test 27.S2 OK!																																						
↓	Wait																																					
Testing 81>S1...																																						

↓	Wait
Test 81>S1 OK!	
↓	Wait
Testing 81>S2...	
↓	Wait
Test 81>S2 OK!	
↓	Wait
Testing 81<S1...	
↓	Wait
Test 81<S1 OK!	
↓	Wait
Testing 81<S2...	
↓	Wait
Test 81<S2 OK!	
↓	Press "Ok"
Auto Test OK!	
↓	Press "Down"
59.S1 threshold 253V 900ms	
↓	Press "Down"
59.S1: 228V 902ms	
↓	Press "Down"
59.S2 threshold 264.5V 200ms	
↓	Press "Down"
59.S2: 229V 204ms	
↓	Press "Down"
27.S1 threshold 195.5V 1500ms	
↓	Press "Down"
27.S1: 228V 1508ms	
↓	Press "Down"
27.S2 threshold 34.5V 200ms	
↓	Press "Down"
27.S2: 227V 205ms	
↓	Press "Down"
81>.S1 threshold 50.5Hz 100ms	
↓	Press "Down"
81>.S1 49.9Hz 103ms	
↓	Press "Down"
81>.S2 threshold 51.5Hz 100ms	
↓	Press "Down"
81>.S2 49.9Hz 107ms	
↓	Press "Down"
81<.S1 threshold 49.5Hz	

100ms	
↓	Press "Down"
81<.S1 50.0Hz 105ms	
↓	Press "Down"
81<.S2 threshold 47.5Hz	
100ms	
↓	Press "Down"
81<.S2 50.1Hz 107ms	

Autotest STD

2.Autotest STD

Press OK to start

The test procedure is same as Autotest Fast, but it's much more time consuming.

6. Input Channel Config

6.Input Channel Config

OK

Input Channel Config		
Input Channel1	Battery input1	Down OK
	Battery input2	
	Disable	
Input Channel2	Battery input1	Down
	Battery input2	
	Disable	
Input Channel3	PV input 1	Down
	PV input 2	
	Disable	
Input Channel4	PV input 1	Down
	PV input 2	
	Disable	

7. EPS Mode

7.EPS Mode

OK

1.EPS Mode Control

OK

1.Enable EPS Mode

OK

2.Disable EPS Mode

1) If PV generation > LOAD consumption ($\Delta P > 100W$), inverter will charge battery.

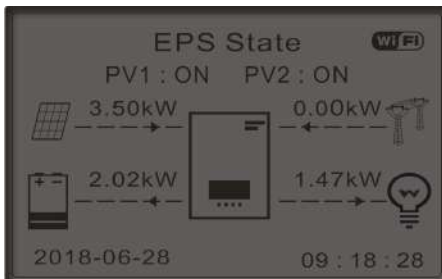

2) If PV generation = LOAD consumption, inverter wont' charge or discharge battery.

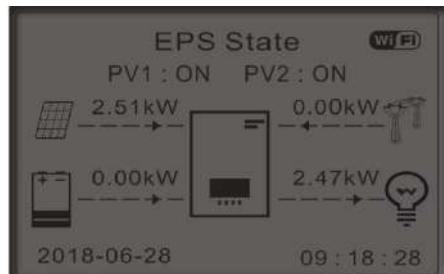

3) If PV generation < LOAD consumption ($\Delta P > 100W$), inverter will discharge battery.

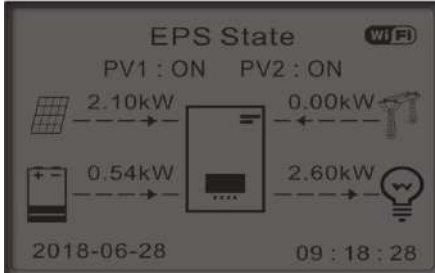

4) If PV generation is normal, but LOAD consumption=0, the surplus power will be stored in the battery.

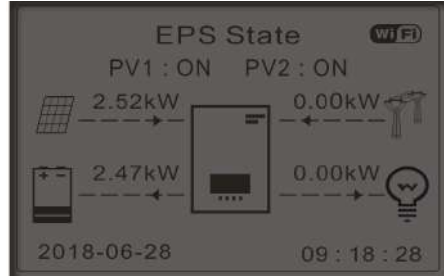

8. Communication Addr

8.Communication Addr	OK	1.Communication Addr	OK
		2.Baud Rate	OK

7.3.2 Advanced setting

2.Advanced setting OK

Input 0001

1.Battery Parameter
2.Battery Active
3.Anti Reflux
4.IV Curve Scan
5.Logic interface Control
6.Factory Reset
7.Parallel setting
8.Bluetooth Reset
9.CT Calibration
10.Switch On Off
11.Unbalanced Support

1. Battery Parameter

1.Battery Parameter	OK	Battery Parameter1	OK
		Battery Parameter2	OK

A.Inner BMS

1.Battery Parameter	OK	1.Battery Type	5.Max Charge (A)
		2.Battery Capacity	6.Max Discharge (A)
		3.Nominol Bat Voltage	7.*Discharg Depth
		4.Battery Cell Type	8.Save

OK

B.PYLON/SOFAR

1.Battery Parameter	OK	1.Battery Type	5.Discharg Depth	OK
		2.Battery Address	6.Set ForceChargeTime	
		3.Max Charge (A)	7.Save	
		4.Max Discharge (A)		

2.Battery Address	Battery Address 1	00
	Battery Address 2	Not Use
	Battery Address 3	Not Use
	Battery Address 4	Not Use

Depth of Discharge

For example: if Discharge Depth = 50% & EPS Discharge Depth = 80%.

While grid is connected: Inverter won't discharge the battery when its SOC is less than 50%.

In case of blackout: Inverter will work in EPS mode (if EPS mode is enabled) & keep discharging the battery till battery SOC is less than 20%.

7.Depth of Discharge	OK	Discharge Depth 50%
		EPS Discharge Depth 80%
		EPS Restore Depth 20%

2. Battery Active

2.Battery Active	OK	Automatic activation	Enable	OK
			Disable	
		Mandatory activation		

This function provides different ways to activate the battery after battery dormancy. When the automatic activation switch-disable, when the input and output meet the conditions for battery activation, the inverter will not automatically activate the battery, it is necessary to set the mandatory activation LCD to enable the inverter to activate the battery. When the automatic activation switch-enabling, the inverter can automatically activate the battery when the input and output meet the conditions for battery activation. When manual click settings force activation, the inverter forces the activation of dormant batteries.

3. Anti Reflux

The user can enable “Anti Reflux Control” to limit the max export power to grid. Reflux Power set is desired max export power to grid. Refer to 5.6.5 for connection of the system when using Anti Reflux function.

3.Anti Reflux	OK	1.Anti Reflux Mode	OK	Disable
		2.Reflux Power		OK
				Anti Reflux
				Threephase limit

4. IV Curve Scan

The user can enable “IV Curve Scan” (MPPT scan) to make inverter to find the global max power point periodically to deliver max power from a partially shaded PV array.

The user can input scan period or make inverter to perform a scan right away.

4.IV Curve Scan	OK	1.Scan Control	OK	Enable	
		2.Scan Period		OK	***min
		3.Force Scan		OK	Disable

5. Logic interface Control

Enable or disable logical interfaces. Please refer to this manual 5.6.2, inverter logic interface connection for details.

5.Logic interface Control	OK	Enable	OK
		Disable	OK

6. Factory Reset

6.Factory Reset	OK	1.Clear Energy Data	OK
		2.Clear Events	OK

Clean the inverter of the total power generation.

1.Clear Energy Data OK OK **Input 0001**

Clean up the historical events recorded in the inverter.

2..Clear Events OK OK

7. Parallel setting

Please refer to <5.6.4 Link Port 0&1-Cascade communication interface> for the connection method of the parallel system.

7.Parallel setting	OK	1.Parallel Control
		2.Parallel Primary-Replica
		3.Parallel Address
		4.Save

1. Parallel Control: Enable or disable parallel functions. Both the master and the slave must enable this function.
2. Parallel Primary-Replica: Set up the Primary and Replica. Select one inverter as the Primary and set the others to Replica.
3. Parallel Address: Set the parallel address. Each inverter needs to set a parallel address, and the parallel address in a parallel system cannot be repeated. (NOTE: The parallel address is different from the communication address used for monitoring.)
4. Save: Save after the setup is complete.
8. Bluetooth Reset

8. Bluetooth Reset	OK	Please confirm!	OK	Success
--------------------	----	-----------------	----	---------

9. CT Calibration

To calibrate the direction and phase of the CT, the battery should be charged or discharged when using this function.

A. The input must be connected to the battery, and the output must be connected to the grid for normal calibration, otherwise the calibration will fail.

B. When carrying unbalanced load, the calibration will fail. It is recommended to turn off the load when carrying out CT calibration.

9. CT Calibration	OK	Calibrating	Success/Fault
-------------------	----	-------------	---------------

Check if the battery is charging or discharging when calibration fails.

10. Switch On Off

10. Switch On Off	OK	Switch On	OK
		Switch Off	OK

Function: the inverter can be controlled by the inverter switch machine through this menu, so that the inverter can be shut down, the inverter can stop working and turn into standby state, and the inverter can be to normal output working state. This function can effectively and safely control the inverter switch machine and facilitate installation and maintenance.

11. Unbalanced Support

The default is prohibited.

Application scenarios: When the system is connected with three-phase unbalanced load or single-phase load, the inverter outputs power to the load, and the remaining

two-phase or three-phase unbalanced output is incorporated into the power grid. This reduces the quality of the grid, and photovoltaic power generation is not used most efficiently.

The customer can set the enable to turn on the three-phase unbalance support, and the inverter can detect and identify the three-phase current unbalance at the common connection points of the grid in the system through the meter or CT. The three-phase unbalanced current is output pertinently to compensate the current imbalance at the public connection point, so that the current at the public connection point of the power grid is always kept in dynamic balance. It can effectively improve the quality of power grid and enhance user benefit.

7.3.3 Energy Statistic

3.Energy Statistic	OK	Today
		PV **KWH
		Load **KWH
		Export **KWH
		Import..... **KWH
		Charge..... **KWH
		Discharge..... **KWH
	Down↓	Month
		PV **KWH
		Load **KWH
		Export **KWH
		Import..... **KWH
		Charge..... **KWH
		Discharge..... **KWH
	Down↓	Year
		PV **KWH
		Load **KWH
		Export **KWH
		Import..... **KWH
		Charge..... **KWH
		Discharge..... **KWH
	Down↓	Lifetime
		PV **KWH
		Load **KWH
		Export **KWH
		Import..... **KWH

Charge.....	***KWH
Discharge.....	***KWH

7.3.4 System information

4.System information	OK	<table border="1"> <tr> <td style="background-color: #e1eef6;">1.Inverter Info</td> </tr> <tr> <td>2.Battery Info</td> </tr> <tr> <td>3.Safety Param.</td> </tr> </table>	1.Inverter Info	2.Battery Info	3.Safety Param.																													
1.Inverter Info																																		
2.Battery Info																																		
3.Safety Param.																																		
1.Inverter Info	OK	<table border="1"> <tr> <td style="background-color: #e1eef6;">Inverter Info (1)</td> </tr> <tr> <td>Product SN</td> </tr> <tr> <td>Software Version</td> </tr> <tr> <td>Main DSP Software Version</td> </tr> <tr> <td>Slave DSP Software Version</td> </tr> <tr> <td>Down↓</td> <td style="background-color: #e1eef6;">Inverter Info (2)</td> </tr> <tr> <td>Hardware Version</td> </tr> <tr> <td>Power Level</td> </tr> <tr> <td>Country</td> </tr> <tr> <td>Down↓</td> <td style="background-color: #e1eef6;">Inverter Info (3)</td> </tr> <tr> <td>Input Channel1</td> </tr> <tr> <td>Input Channel2</td> </tr> <tr> <td>Input Channel3</td> </tr> <tr> <td>Input Channel4</td> </tr> <tr> <td>Down↓</td> <td style="background-color: #e1eef6;">Inverter Info (4)</td> </tr> <tr> <td>Energy Storage Mode</td> </tr> <tr> <td>RS485 Address</td> </tr> <tr> <td>EPS Mode</td> </tr> <tr> <td>IV Curve Scan</td> </tr> <tr> <td>Down↓</td> <td style="background-color: #e1eef6;">Inverter Info (5)</td> </tr> <tr> <td>Logic Interface Control</td> </tr> <tr> <td>PF Time Setting</td> </tr> <tr> <td>QV Time Setting</td> </tr> <tr> <td>Power Factor</td> </tr> <tr> <td>Down↓</td> <td style="background-color: #e1eef6;">Inverter Info (6)</td> </tr> <tr> <td>Anti Reflux</td> </tr> <tr> <td>Insulation resistance</td> </tr> </table>	Inverter Info (1)	Product SN	Software Version	Main DSP Software Version	Slave DSP Software Version	Down↓	Inverter Info (2)	Hardware Version	Power Level	Country	Down↓	Inverter Info (3)	Input Channel1	Input Channel2	Input Channel3	Input Channel4	Down↓	Inverter Info (4)	Energy Storage Mode	RS485 Address	EPS Mode	IV Curve Scan	Down↓	Inverter Info (5)	Logic Interface Control	PF Time Setting	QV Time Setting	Power Factor	Down↓	Inverter Info (6)	Anti Reflux	Insulation resistance
Inverter Info (1)																																		
Product SN																																		
Software Version																																		
Main DSP Software Version																																		
Slave DSP Software Version																																		
Down↓	Inverter Info (2)																																	
Hardware Version																																		
Power Level																																		
Country																																		
Down↓	Inverter Info (3)																																	
Input Channel1																																		
Input Channel2																																		
Input Channel3																																		
Input Channel4																																		
Down↓	Inverter Info (4)																																	
Energy Storage Mode																																		
RS485 Address																																		
EPS Mode																																		
IV Curve Scan																																		
Down↓	Inverter Info (5)																																	
Logic Interface Control																																		
PF Time Setting																																		
QV Time Setting																																		
Power Factor																																		
Down↓	Inverter Info (6)																																	
Anti Reflux																																		
Insulation resistance																																		
2.Battery Info	OK	<table border="1"> <tr> <td style="background-color: #e1eef6;">Battery1/2 info(1)</td> </tr> <tr> <td>Battery Type</td> </tr> <tr> <td>Battery Capacity</td> </tr> <tr> <td>Over (V) Protection</td> </tr> <tr> <td>Discharge Depth</td> </tr> </table>	Battery1/2 info(1)	Battery Type	Battery Capacity	Over (V) Protection	Discharge Depth																											
Battery1/2 info(1)																																		
Battery Type																																		
Battery Capacity																																		
Over (V) Protection																																		
Discharge Depth																																		

	Down↓	Inverter1/2 Info (2)
		Max Charge (A)
		Max Charge (V)
		Max Discharge (A)
		Min Discharge (V)
	Down↓	Inverter1/2 Info (3)
		Low(V)Protection
		Nominal Bat Voltage
3.Safety Param.	OK	Safety Param.(1)
		OVP 1
		OVP 2
		UVP 1
		UVP 2
	Down↓	Safety Param. (2)
		OF1 1
		OF1 2
		UFP 1
		UFP 2
	Down↓	Safety Param. (3)
		OVP 10mins

7.3.5 Event List

Event List is used to display the real-time event records, including the total number of events and each specific ID No. and happening time. User can enter Event List interface through main interface to check details of real-time event records, Event will be listed by the happening time, and recent events will be listed in the front.

5.Event List	OK	1.Current Event List	OK	ID042 IsoFault
		2.History Event List		
2.History Event List	OK	1.ID001 2020-4-3 14:11:45	OK	1.ID001 GridOVP
		2.ID005 2020-4-3 11:26:38		2.ID005 GFCI

7.3.6 Software Update

HYD 5-20KTL-3PH inverters offer software upgrade via usb flash drive to maximize inverter performance and avoid inverter operation error caused by software bugs.

Step 1 Insert the usb flash drive into the compute.

Step 2 SOFAR SOLAR will send the Software code to the user who needs to update. After user receive the file,please decompressing file and cover the original file in usb flash drive.

Step 4 Insert the usb flash drive into the USB/Wifi interface.

Step 5 Then turn on DC switch.

Step 6

6.Software Update	OK	Input password	OK Input 0715
			Start Update
			Updating DSP1
			Updating DSP2
			Updating ARM

Step 7 If the following errors occur, please upgrade again.If this continues many times, contact technical support for help.

USB Fault	MDSP File Error	SDSP File Error
ARM File Error	Update DSP1 Fail	Update DSP2 Fail
Update ARM Fail		

Step 8 After the update is completed,turn off the DC breaker, wait for the LCD screen extinguish, then restore the WiFi connection and then turn on the DC breaker and AC breaker again,the inverter will enters the running state. User can check the current software version in SystemInfo>>>SoftVersion.

8. Troubleshooting

This section contains information and procedures for solving possible problems with the inverter.

➤ This section help users to identify the inverter fault. Please read the following procedures carefully:

✧ Check the warning, fault messages or fault codes shown on the inverter screen, record all the fault information.

✧ If there is no fault information shown on the screen, check whether the following requirements are met:

- Is the inverter mounted in a clean, dry place with good ventilation?
- Is the DC switch turned ON?
- Are the cables adequately sized and short enough?
- Are the input and output connections and wiring in good condition?
- Are the configuration settings correct for the particular installation?
- Are the display panel and the communication cables properly connected and undamaged?

If the inverter needs to be shut down for electrical inspection, please follow the following steps:

1. Press the "Back" on the main interface to enter the main menu page, and select Advanced Settings - On/off machine control - Shutdown. Make the inverter shut down safely.

Note: after using the menu setting to shut down the inverter, the inverter should be checked and reenergizing, it still needs to be on the main menu page. Select advanced Settings - switch machine control - start up to enable the inverter to start up and run.

2. Disconnect the AC circuit breaker connecting the inverter power grid port to the power grid.
3. Disconnect the AC breaker connecting the inverter load port to the emergency load.

4. Disconnect the PV side DC switch.
5. Turn off the battery and disconnect the DC switch between the battery and the inverter.
6. Wait for 5 minutes before checking the inverter.
 - Follow the steps below to view recorded problems: Press "Back" to enter the main menu in the normal interface. In the interface screen select "Event List", then press "OK" to enter events.
 - Earth Fault Alarm

This inverter complies with IEC 62109-2 clause 13.9 for earth fault alarm monitoring.

If an Earth Fault Alarm occurs, the fault will be displayed on the LCD screen, the red light will be on, and the fault can be found in the history of the fault. For the machine installed with WiFi/GPRS, the alarm information can be seen on the corresponding monitoring website, and can also be received by the APP on the mobile phone.

- EventList information

Table 8-1 Eventlist

Code	Name	Description	Solution
ID001	GridOVP	The grid voltage is too high	If the alarm occurs occasionally, the possible cause is that the electric grid is abnormal occasionally. Inverter will automatically return to normal operating status when the electric grid's back to normal.
ID002	GridUVP	The grid voltage is too low	
ID003	GridOFP	The grid frequency is too high	
ID004	GridUFP	The grid frequency is too low	If the alarm occurs frequently, check whether the grid voltage/frequency is within the acceptable range. If yes, please check the AC circuit breaker and AC wiring of the inverter. If the grid voltage/frequency is NOT within the acceptable range and AC wiring is correct, but the alarm occurs repeatedly, contact technical support to change the grid over-voltage, under-voltage, over-frequency, under-frequency protection points after obtaining approval from the local electrical grid operator.
ID005	GFCI	Charge Leakage Fault	Internal faults of inverter, switch OFF inverter, wait for 5 minutes, then switch ON inverter. Check whether the problem is
ID006	OVRT fault	OVRT function is faulty	

ID007	LVRT fault	LVRT function is faulty	solved.
ID008	IslandFault	Island protection error	If no, please contact technical support.
ID009	GridOVPIstant1	Transient overvoltage of grid voltage 1	
ID010	GridOVPIstant2	Transient overvoltage of grid voltage 2	
ID011	VGridLineFault	Power grid line voltage error	
ID012	InvOVP	Inverter voltage overvoltage	
ID017	HwADFaultIGrid	Power grid current sampling error	
ID018	HwADFaultDCI	Wrong sampling of dc component of grid current	
ID019	HwADFaultVGri d(DC)	Power grid voltage sampling error (DC)	
ID020	HwADFaultVGri d(AC)	Power grid voltage sampling error (AC)	
ID021	GFCIDeviceFault (DC)	Leakage current sampling error (DC)	
ID022	GFCIDeviceFault (AC)	Leakage current sampling error (AC)	
ID023	HwADFaultDCV	Error in dc component sampling of load voltage	
ID024	HwADFaultIdc	Dc input current sampling error	
ID029	ConsistentFault_ GFCI	Leakage current consistency error	
ID030	ConsistentFault_ Vgrid	Grid voltage consistency error	
ID033	SpiCommFault(D C)	SPI communication error (DC)	
ID034	SpiCommFault(A C)	SPI communication error (AC)	
ID035	SChip_Fault	Chip error (DC)	
ID036	MChip_Fault	Chip error (AC)	
ID037	HwAuxPowerFau lt	Auxiliary power error	
ID041	RelayFail	Relay detection failure	
ID042	IsoFault	Low insulation impedance	Check the insulation resistance between the photovoltaic array and ground (ground), if there is a short circuit, the fault should be repaired in time.
ID043	PEConnectFault	Ground fault	Check ac output PE wire for grounding.
ID044	PvConfigError	Error setting input mode	Check the PV input mode (parallel/independent mode) Settings for the

			inverter. If not, change the PV input mode.
ID045	CTDisconnect	CT error	Check whether the CT wiring is correct.
ID049	TempFault_Bat	Battery temperature protection	<p>Make sure the inverter is installed where there is no direct sunlight. Please ensure that the inverter is installed in a cool/well ventilated place. Ensure the inverter is installed vertically and the ambient temperature is below the inverter temperature limit.</p>
ID050	TempFault_Heat Sink1	Radiator 1 temperature protection	
ID051	TempFault_Heat Sink2	Radiator 2 temperature protection	
ID052	TempFault_Heat Sin3	Radiator 3 temperature protection	
ID053	TempFault_Heat Sink4	Radiator 4 temperature protection	
ID054	TempFault_Heat Sin5	Radiator 5 temperature protection	
ID055	TempFault_Heat Sin6	Radiator 6 temperature protection	
ID057	TempFault_Env1	Ambient temperature 1 protection	
ID058	TempFault_Env2	Ambient temperature 2 protection	
ID059	TempFault_Inv1	Module 1 temperature protection	
ID060	TempFault_Inv2	Module 2 temperature protection	
ID061	TempFault_Inv3	Module 3 temperature protection	
ID065	VbusRmsUnbalance	Unbalanced bus voltage RMS	
ID066	VbusInstantUnbalance	The transient value of bus voltage is unbalanced	
ID067	BusUVP	Busbar undervoltage during grid-connection	
ID068	BusZVP	Bus voltage low	
ID069	PVOVP	PV over-voltage	Check whether the PV series voltage (Voc) is higher than the maximum input voltage of the inverter. If so, adjust the number of PV modules in series and reduce the PV series voltage to fit the input voltage range of the inverter. After correction, the inverter will automatically return to its normal state.
ID070	BatOVP	Battery over-voltage	Check whether the battery overvoltage setting is inconsistent with the battery specification.
ID071	LLCBusOVP	LLC BUS overvoltage protection	<p>Internal faults of inverter, switch OFF inverter, wait for 5 minutes, then switch ON inverter. Check whether the problem is solved.</p>
ID072	SwBusRmsOVP	Inverter bus voltage RMS software	

			overvoltage	If no, please contact technical support.
ID073	SwBusInstantOVP	Inverter bus voltage instantaneous value software overvoltage		
ID081	SwBatOCP	Battery overcurrent software protection		
ID082	DciOCP	Dci overcurrent protection		
ID083	SwOCPInstant	Output instantaneous current protection		
ID084	SwBuckBoostOCP	BuckBoost software flow		
ID085	SwAcRmsOCP	Output effective value current protection		
ID086	SwPvOCPInstant	PV overcurrent software protection		
ID087	IpvUnbalance	PV flows in uneven parallel		
ID088	IacUnbalance	Unbalanced output current		
ID097	HwLLCBusOVP	LLC bus hardware overvoltage		
ID098	HwBusOVP	Inverter bus hardware overvoltage		
ID099	HwBuckBoostOCP	BuckBoost hardware overflows		
ID100	HwBatOCP	Battery hardware overflows		
ID102	HwPVOCP	PV hardware overflows		
ID103	HwACOCP	Ac output hardware overflows		
ID110	Overload1	Overload protection 1	Please check whether the inverter is operating under overload.	
ID111	Overload2	Overload protection 2		
ID112	Overload3	Overload protection 3		
ID113	OverTempDerating	Internal temperature is too high.	Make sure the inverter is installed where there is no direct sunlight. Please ensure that the inverter is installed in a cool/well ventilated place. Ensure the inverter is installed vertically and the ambient temperature is below the inverter temperature limit.	
ID114	FreqDerating	AC frequency is too high	Please make sure the grid frequency and voltage is within the acceptable range.	
ID115	FreqLoading	AC frequency is too low		
ID116	VoltDerating	AC voltage is too high		
ID117	VoltLoading	AC voltage is too low		

ID124	BatLowVoltageAlarm	Battery low voltage protection	Please check whether the battery voltage of the inverter is too low.
ID125	BatLowVoltageShut	Battery low voltage shutdown	
ID129	unrecoverHwAcOCP	Output hardware overcurrent permanent failure	Internal faults of inverter, switch OFF inverter, wait for 5 minutes, then switch ON inverter. Check whether the problem is solved. If no, please contact technical support.
ID130	unrecoverBusOVP	Permanent Bus overvoltage failure	
ID131	unrecoverHwBusOVP	Permanent Bus hardware overvoltage failure	
ID132	unrecoverIpvUnbalance	PV uneven flow permanent failure	
ID133	unrecoverEPSBatOCP	Permanent battery overcurrent failure in EPS mode	
ID134	unrecoverAcOCPInstant	Output transient overcurrent permanent failure	
ID135	unrecoverIacUnbalance	Permanent failure of unbalanced output current	
ID137	unrecoverPvConfigError	Input mode setting error permanent failure	Check the PV input mode (parallel/independent mode) Settings for the inverter. If not, change the PV input mode.
ID138	unrecoverPVOCPInstant	Input overcurrent permanent fault	
ID139	unrecoverHwPVOCP	Input hardware overcurrent permanent failure	Internal faults of inverter, switch OFF inverter, wait for 5 minutes, then switch ON inverter. Check whether the problem is solved. If no, please contact technical support.
ID140	unrecoverRelayFail	Permanent relay failure	
ID141	unrecoverVbusUnbalance	Bus voltage unbalanced permanent failure	
ID145	USBFault	USB fault	Check the USB port of the inverter
ID146	WifiFault	Wifi fault	Check the Wifi port of the inverter
ID147	BluetoothFault	Bluetooth fault	Check the bluetooth connection of the inverter
ID148	RTCFault	RTC clock failure	Internal faults of inverter, switch OFF inverter, wait for 5 minutes, then switch ON inverter. Check whether the problem is solved. If no, please contact technical support.
ID149	CommEEPROMFault	Communication board EEPROM error	
ID150	FlashFault	Communication board FLASH error	
ID153	SciCommLose(DC)	SCI communication error (DC)	
ID154	SciCommLose(AC)	SCI communication error (AC)	
ID155	SciCommLose(F)	SCI communication	

	use)	error (Fuse)	
ID156	SoftVerError	Inconsistent software versions	Contact for technical support and software upgrades.
ID157	BMSCommunicationFault	Communication failure of lithium battery	Make sure your battery is compatible with the inverter. CAN communication is recommended. Check the communication line or port of the battery and inverter for faults.
ID161	ForceShutdown	Force shutdown	The inverter is performed a forced shutdown
ID162	RemoteShutdown	Remote shutdown	The inverter is performed a remote shutdown.
ID163	Drms0Shutdown	Drms0 shutdown	The inverter is performed with a Drms0 shutdown.
ID165	RemoteDerating	Remote derating	The inverter is performed for remote load reduction.
ID166	LogicInterfaceDerating	Logic interface derating	The inverter is loaded by the execution logic interface.
ID167	AlarmAntiRefluxing	Anti reflux derating	The inverter is implemented to prevent countercurrent load drop.
ID169	FanFault1	Fan 1 fault	Please check whether the fan 1 of inverter is running normally.
ID170	FanFault2	Fan 2fault	Please check whether the fan 2 of inverter is running normally.
ID171	FanFault3	Fan 3 fault	Please check whether the fan 3 of inverter is running normally.
ID172	FanFault4	Fan 4 fault	Please check whether the fan 4 of inverter is running normally.
ID173	FanFault5	Fan 5 fault	Please check whether the fan 5 of inverter is running normally.
ID174	FanFault6	Fan 6 fault	Please check whether the fan 6 of inverter is running normally.
ID177	BMS OVP	BMS over-voltage alarm	Internal failure of lithium battery, close inverter and lithium battery, and wait 5 minutes to open inverter and lithium battery. Check that the problem is resolved. If not, please contact technical support.
ID178	BMS UVP	BMS under-voltage alarm	
ID179	BMS OTP	BMS high temperature warning	
ID180	BMS UTP	BMS low temperature alarm	
ID181	BMS OCP	Warning of overload in charge and discharge of BMS	
ID182	BMS Short	BMS short circuit alarm	

Maintenance

Inverters generally do not need any daily or routine maintenance. Heat sink should

not be blocked by dust, dirt or any other items. Before the cleaning, make sure that the DC SWITCH is turned OFF and the circuit breaker between inverter and electrical grid is turned OFF. Wait at least for 5 minutes before the Cleaning.

✧ **Inverter cleaning**

Please clean the inverter with an air blower, a dry & soft cloth or a soft bristle brush. Do NOT clean the inverter with water, corrosive chemicals, detergent, etc.

✧ **Heat sink cleaning**

For the long-term proper operation of inverters, ensure there is enough space around the heat sink for ventilation, check the heat sink for blockage (dust, snow, etc.) and clean them if they exist. Please clean the heat sink with an air blower, a dry & soft cloth or a soft bristle brush. Do NOT clean the heat sink with water, corrosive chemicals, detergent, etc.

9. Technical Data

Battery Parameters

Datasheet	HYD 5KTL- 3PH	HYD 6KTL- 3PH	HYD 8KTL- 3PH	HYD 10KTL -3PH	HYD 15KTL -3PH	HYD 20KTL -3PH
Battery type	Li-Ion& Lead-acid					
No. of battery input	1			2		
Battery voltage range	180V-800V					
Battery voltage range for full load(V)	200-800	240-800	320-800	200-800	300-800	400-800
Nominal. charging/discharging power(W)	5000	6000	8000	10000	15000	20000
Max. charging/discharging current	25A			50A(25A/25A)		
Peak charging/discharging current, Duration	40A, 60s			70A(35A/35A), 60s		
Charging strategy	Follow BMS					
Battery capacity	25Ah~100Ah					
Communication interfaces	CAN(RS485)					

PV String Input Data

Datasheet	HYD 5KTL- 3PH	HYD 6KTL- 3PH	HYD 8KTL- 3PH	HYD 10KTL -3PH	HYD 15KTL -3PH	HYD 20KTL -3PH
Recommended Max.PV power	7500 (6000/ 6000)	9000 (6600/ 6600)	12000 (6600/ 6600)	15000 (7500/ 7500)	22500 (11250/ 11250)	30000 (15000/ 15000)
Max DC voltage	1000V					
Start-up voltage	200V					
MPPT voltage range	180-960V					
Rated DC voltage	600V					
No. of MPP trackers	2					
No. of strings per MPP tracker	1			2		
Full power MPPT voltage range(V)	250-850	320-850	360-850	220-850	350-850	450-850
Max. Input current	12.5A/12.5A			25A/25A		
Max short-circuit current	15A/15A			30A/30A		

AC Output Data (ON-Grid)

Datasheet	HYD 5KTL- 3PH	HYD 6KTL- 3PH	HYD 8KTL- 3PH	HYD 10KTL -3PH	HYD 15KTL -3PH	HYD 20KTL -3PH
Nominal AC power(W)	5000	6000	8000	10000	15000	20000
Max. AC power output to utility grid(VA)	5500	6600	8800	11000	16500	22000
Max. AC power from utility grid(VA)	10000	12000	16000	20000	30000	40000
Max. AC current output to utility grid	8A	10A	13A	16A	24A	32A
Max. AC Current from utility grid	15A	17A	24A	29A	44A	58A
Nominal grid voltage	3/N/PE, 220/380Vac, 230/400Vac					
Grid voltage range	184Vac~276Vac					
Nominal grid frequency	50Hz/60Hz					
Grid frequency range	45Hz~55Hz/55Hz~65Hz					
Output power factor	1(0.8 leading to 0.8 lagging)					
Output THDi (@Nominal output)	<3%					

AC Output Data (Off-Grid)

Datasheet	HYD 5KTL- 3PH	HYD 6KTL- 3PH	HYD 8KTL- 3PH	HYD 10KTL -3PH	HYD 15KTL -3PH	HYD 20KTL -3PH
Nominal output power(W)	5000	6000	8000	10000	15000	20000
Max. output power(VA)	5500	6600	8800	11000	16500	22000
Peak output power, Duration	10000V A,60s	12000V A,60s	16000V A,60s	20000V A,60s	22000V A,60s	22000V A,60s
Max. output current	8A	10A	13A	16A	24A	32A
Peak output current, Duration	15A,60s	18A,60s	24A,60s	30A,60s	32A,60s	32A,60s
Nominal output voltage	3/N/PE, 220/380Vac, 230/400Vac					
Nominal output frequency	50/60Hz					
Output THDv (@Liner load)	<3%					
Switch time	<20ms					

Efficiency And Protection

Datasheet	HYD 5KTL-3PH	HYD 6KTL-3PH	HYD 8KTL-3PH	HYD 10KTL-3PH	HYD 15KTL-3PH	HYD 20KTL-3PH
MPPT efficiency	99.9%					
Euro efficiency	97.5%	97.5%	97.5%	97.7%	97.7%	97.7%
Max. efficiency	98.0%	98.0%	98.0%	98.2%	98.2%	98.2%
Max. battery charge/discharge efficiency	97.6%	97.6%	97.6%	97.8%	97.8%	97.8%
DC switch	Yes					
PV reverse polarity protection	Yes					
Output over current protection	Yes					
Output over voltage protection	Yes					
Anti-islanding protection	Yes					
Residual current detection	Yes					
Insulation resistor detection	Yes					
Surge protection level	II					
Battery reverse protection	Yes					

General Data

Datasheet	HYD 5KTL- 3PH	HYD 6KTL- 3PH	HYD 8KTL- 3PH	HYD 10KTL -3PH	HYD 15KTL -3PH	HYD 20KTL -3PH
Dimension	571.4mm*515mm*264.1mm					
Weight	33kg			37kg		
Inverter topology	Transformerless					
Standby self consumption	<15W					
Operating temperature range	-30°C~60°C					
Relative humidity	0~100%					
Noise	<45dB					
Operating altitude	<4000m					
Cooling	Natural			Forced airflow		
Protection degree	IP65					

Feature And Standard

Datasheet	HYD 5KTL- 3PH	HYD 6KTL- 3PH	HYD 8KTL- 3PH	HYD 10KTL -3PH	HYD 15KTL -3PH	HYD 20KTL -3PH
DC terminal	MC4					
Grid AC terminal	5P Connector					
Back-up AC terminal	5P Connector					
Display	LCD Display					
Monitoring interfaces	Bluetooth / RS485 / WIFI / GPRS (optional)					
Parallel operation	Yes					
Standard warranty	Standard 5/7/10 (Australia) years					
Grid	AS/NZS 4777, VDE V 0124-100, V0126-1-1, VDE-AR-N 4105, CEI 0-21/CEI 0-16, EN50438/EN50549, G83/G59/G98/G99, UTE C15-712-1, UNE206 007-1					
Safety	IEC62109-1, IEC62109-2, NB-T32004/IEC62040-1					
EMC	EN61000-1, EN61000-2, EN61000-3, EN61000-4, EN61000-4-16, EN61000-4-18, EN61000-4-29					

10. *Quality Assurance*

Standard warranty period

The standard warranty period of inverter is 60 months (5 years). There are two calculation methods for the warranty period:

1. Purchase invoice provided by the customer: the first flight provides a standard warranty period of 60 months (5 years) from the invoice date;
2. The customer fails to provide the invoice: from the production date (according to the SN number of the machine), Our company provides a warranty period of 63 months (5.25 years).
3. In case of any special warranty agreement, the purchase agreement shall prevail.

Extended warranty period

Within 12 months of the purchase of the inverter (based on the purchase invoice) or within 24 months of the production of the inverter(SN number of machine, based on the first date of arrival),Customers can apply to buy extended warranty products from the company's sales team by providing the product serial number, Our company may refuse to do not conform to the time limit extended warranty purchase application. Customers can buy an extended warranty of 5, 10, 15 years.

If the customer wants to apply for the extended warranty service, please contact the sales team of our company. to purchase the products that are beyond the purchase period of extended warranty but have not yet passed the standard quality warranty period. Customers shall bear different extended premium.

During the extended warranty period, pv components GPRS, WIFI and lightning protection devices are not included in the extended warranty period. If they fail during the extended warranty period, customers need to purchase and replace them from our company.

Once the extended warranty service is purchased, our company will issue the extended warranty card to the customer to confirm the extended warranty period.

Invalid warranty clause

Equipment failure caused by the following reasons is not covered by the warranty:

- 1) The "warranty card" has not been sent to the distributor or our company;
- 2) Without the consent of our company to change equipment or replace parts;
- 3) Use unqualified materials to support our company's products, resulting in product failure;

- 4) Technicians of non-company modify or attempt to repair and erase the product serial number or silk screen;
- 5) Incorrect installation, debugging and use methods;
- 6) Failure to comply with safety regulations (certification standards, etc.);
- 7) Damage caused by improper storage by dealers or end users;
- 8) Transportation damage (including scratches caused by internal packaging during transportation). Please claim directly from the transportation company or insurance company as soon as possible and obtain damage identification such as container/package unloading;
- 9) Failure to follow the product user manual, installation manual and maintenance guidelines;
- 10) Improper use or misuse of the device;
- 11) Poor ventilation of the device;
- 12) The product maintenance process does not follow relevant standards;
- 13) Failure or damage caused by natural disasters or other force majeure (such as earthquake, lightning strike, aware fire, etc.)

Statement

If you have purchased this product in Australia, you should be aware that this warranty is provided in addition to other rights and remedies held by a consumer at law.

Our goods come with guarantees that cannot be excluded under the Australian Consumer Law. You are entitled to a replacement or refund for a major failure and compensation for any other reasonably foreseeable loss or damage. You are also entitled to have the goods repaired or replaced if the goods fail to be of acceptable quality and the failure does not amount to a major failure.



Product Name: Energy storage integrated inverter

Company Name: Shenzhen SOFARSOLAR Co., Ltd.

ADD: 401, Building 4, AnTongDa Industrial Park, District 68, XingDong Community,
XinAn Street, BaoAn District, Shenzhen, Guangdong.P.R. China

Email: service@sofarsolar.com

Tel: 0510-6690 2300

Web: www.sofarsolar.com